



DL650A

OWNER'S MANUAL

This owner's manual contains
important safety information.
Please read it carefully.

Part No. 99011-27G62-03A
July, 2008 (TK) EN

California Proposition 65 Warning

WARNING

Engine exhaust, some of its constituents, and certain product components contain or emit chemicals known to the State of California to cause cancer and birth defects or other reproductive harm.

This manual should be considered a permanent part of the motorcycle and should remain with the motorcycle when resold or otherwise transferred to a new owner or operator. The manual contains important safety information and instructions which should be read carefully before operating the motorcycle.

IMPORTANT

WARNING/CAUTION/NOTE

Please read this manual and follow its instructions carefully. To emphasize special information, the symbol ▲ and the words WARNING, CAUTION and NOTE have special meanings. Pay special attention to the messages highlighted by these signal words:

▲ WARNING

Indicates a potential hazard that could result in death or injury.

CAUTION

Indicates a potential hazard that could result in motorcycle damage.

NOTE: Indicates special information to make maintenance easier or instructions clearer.

WARNINGS and CAUTIONS are arranged like this:

▲ WARNING-or-CAUTION

The first part will describe a **POTENTIAL HAZARD** and **WHAT CAN HAPPEN** if you ignore the **WARNING** or **CAUTION**.

The second part will describe **HOW TO AVOID THE HAZARD**.

FOREWORD

Motorcycling is one of the most exhilarating sports and to ensure your riding enjoyment, you should become thoroughly familiar with the information presented in this Owner's Manual before riding the motorcycle.

The proper care and maintenance that your motorcycle requires is outlined in this manual. By following these instructions explicitly you will ensure a long trouble-free operating life for your motorcycle. This motorcycle also conforms to the U.S. Environmental Protection Agency emission regulations which apply to new motorcycles. The proper adjustment of engine components is necessary for this motorcycle to comply with the EPA regulations. Therefore, please follow the maintenance instructions closely to ensure emission compliance. Your Suzuki dealer has experienced technicians that are trained to provide your machine with the best possible service with the right tools and equipment.

All information, illustrations and specifications contained in this manual are based on the latest product information available at the time of publication. Due to improvements or other changes, there may be some discrepancies between information in this manual and your motorcycle. Suzuki reserves the right to make production changes at any time, without notice and without incurring any obligation to make the same or similar changes to vehicles previously built or sold.

Suzuki Motor Corporation believes in conservation and protection of Earth's natural resources. To that end, we encourage every vehicle owner to recycle, trade in, or properly dispose of, as appropriate, used motor oil, coolant, and other fluids, batteries and tires.



SUZUKI MOTOR CORPORATION

© COPYRIGHT SUZUKI MOTOR
CORPORATION 2008

TABLE OF CONTENTS

THE SPORT OF MOTORCYCLING

1

FUEL, ENGINE OIL AND COOLANT RECOMMENDATIONS

2

CONTROLS, EQUIPMENT AND ADJUSTMENTS

3

BREAK-IN AND INSPECTION BEFORE RIDING

4

RIDING TIPS

5

ACCESSORY USE AND MOTORCYCLE LOADING

6

INSPECTION AND MAINTENANCE

7

TROUBLESHOOTING

8

STORAGE PROCEDURE AND MOTORCYCLE CLEANING

9

CONSUMER INFORMATION

10

SPECIFICATIONS

INDEX

THE SPORT OF MOTORCYCLING

MOST ACCIDENTS CAN BE AVOIDED	1-2
IF YOU DON'T HAVE A HELMET - BUY A HELMET, AND WEAR IT EVERY TIME YOU RIDE	1-2
IF A COLLISION IS IMMINENT, DO SOMETHING!	1-3
SPECIAL SITUATIONS REQUIRE SPECIAL CARE	1-3
KNOW YOUR LIMITS	1-4
BE EXTRA SAFETY-CONSCIOUS ON BAD WEATHER DAYS	1-4
PRACTICE AWAY FROM TRAFFIC	1-4
INSPECTION BEFORE RIDING	1-5
ACCESSORIES AND LOADING	1-5
CARRYING A PASSENGER	1-5
MOTORCYCLE SAFETY FOUNDATION'S "RIDING TIPS AND PRACTICE GUIDE" HANDBOOK (FOR OWNERS IN USA)	1-6
BE STREET SMART	1-6
CONCLUSION	1-6

THE SPORT OF MOTORCYCLING

Your motorcycle and this owner's manual have been designed by people like you who enjoy motorcycling. People become motorcyclists for many reasons. For starters, street riding is fun and invigorating. But no matter why you became a motorcyclist, or how experienced you are, you will eventually face some challenging situations.

In preparing for these challenges, you will be fine-tuning your coordination, concentration, and attitude. Learning the skills and strategies associated with motorcycling is the basis for safely participating in this sport. Many motorcyclists find that as they become better riders, they also get more enjoyment from the freedom unique to motorcycling.

Please remember:

MOST ACCIDENTS CAN BE AVOIDED

The most common type of motorcycle accident in the U.S. occurs when a car traveling towards a motorcycle turns left in front of the motorcycle. Is that because other drivers are out to get motorcyclists? No. Other drivers simply don't always notice motorcyclists.

Ride defensively. Wise motorcyclists use a strategy of assuming they are invisible to other drivers, even in broad daylight. Pay careful attention to other motorists, especially at intersections, because they may not be paying attention to you. Select a lane position that gives you the best view of others, and other motorists the best view of you. Wear bright, reflective clothing. Put reflective strips on your helmet.

IF YOU DON'T HAVE A HELMET - BUY A HELMET, AND WEAR IT EVERY TIME YOU RIDE

Most accidents occur within a few miles of home, and almost half occur at speeds of less than 30 mph. So even if you're just going on a quick errand, be prepared – strap on your helmet before you take off.

Helmets do not reduce essential vision or hearing. Generally, helmets do not cause or intensify injury if you crash. Helmets simply help your skull protect your intelligence, your memory, your personality, and your life.

Your eyesight is equally valuable. Wearing suitable eye protection can help keep your vision unblurred by the wind and save your eyes from airborne hazards like bugs, dirt, or pebbles kicked up by tires.

IF A COLLISION IS IMMINENT, DO SOMETHING!

Many riders fear locking up their brakes or haven't learned to swerve to avoid an accident. Many inexperienced riders (and too many seasoned riders) use only their rear brake in an emergency, resulting in unnecessary impacts in some cases and unnecessarily high impact speeds in other cases. Your rear brake can only provide about 30% of your motorcycle's potential stopping power. The front and rear brakes can and should be used together to maximize braking effectiveness.

Experienced motorcyclists learn to "cover" the front brake lever by lightly resting a couple of fingers over the lever when riding in traffic and near intersections to give their reaction time a head start.

Emergency stopping and swerving are techniques that you should practice and master before you find yourself in an emergency situation. The best place to practice such techniques is in a controlled environment such as the Motorcycle Safety Foundation's (MSF) rider training courses. The MSF's Motorcycle Rider Courses (fundamental techniques) and Experienced Rider Courses (advanced strategies) present hands-on instruction of the basic principles of motorcycling and a variety of accident-avoidance

maneuvers. Even a seasoned motorcyclist can improve his or her riding skills, and pick up a few new skills, through these courses. Some insurance companies even offer discounts to course graduates.

SPECIAL SITUATIONS REQUIRE SPECIAL CARE

Of course, there are some times when full-force braking is not the correct technique. When the road surface is wet, loose, or rough, you should brake with care. When you're leaned over in a corner, avoid braking. Straighten up before braking. Better yet, slow down before entering a corner.

In these situations, the traction available between your tires and the road surface is limited. Over-braking when traction is limited will cause your tires to skid, possibly resulting in loss of directional control or causing you and your motorcycle to fall over.

KNOW YOUR LIMITS

Always ride within the boundaries of your own skills. Knowing these limits and staying within them will help you avoid accidents.

A major cause of accidents involving only a motorcycle (and no cars) is going too fast through a turn. Before entering a turn, select an appropriately low cornering speed. Even on straight roads, ride at a speed that is appropriate for the traffic, visibility and road conditions, your motorcycle, and your experience.

Riding a motorcycle safely requires that your mental and physical skills are fully part of the experience. You should not attempt to operate a motor vehicle, especially one with two wheels, if you are tired or under the influence of alcohol or other drugs. Alcohol, illegal drugs, and even some prescription and over-the-counter drugs can cause drowsiness, loss of coordination, loss of balance, and especially the loss of good judgment. If you are tired or under the influence of alcohol or other drugs, **PLEASE DO NOT RIDE** your motorcycle.

BE EXTRA SAFETY-CONSCIOUS ON BAD WEATHER DAYS

Riding on bad weather days, especially wet ones, requires extra caution. Braking distances increase on a rainy day. Stay off the painted surface marks, manhole covers, and greasy-appearing areas, as they can be especially slippery. Use extra caution at railway crossings and on metal gratings and bridges. When it starts to rain, any oil or grease on the road rises to the surface of the water. Pull over and wait a few minutes until this oil film is washed away before riding. Whenever in doubt about road conditions, slow down !

PRACTICE AWAY FROM TRAFFIC

Your riding skill and your mechanical knowledge form the foundation for safe riding practices. We suggest that you practice riding your motorcycle in a non-traffic situation until you are thoroughly familiar with your machine and its controls. Again, consider taking one of the MSF's Rider Courses. Even experts will be pleased with the caliber of the information presented in these courses. As the MSF says: "The more you know, the better it gets !"

INSPECTION BEFORE RIDING

Review the instructions in the “INSPECTION BEFORE RIDING” section of this manual. Perform an entire pre-ride inspection before you head out on the road. Spending a few minutes preparing your machine for a ride can help prevent accidents due to mechanical failure or costly, inconvenient breakdowns far from home.

ACCESSORIES AND LOADING

The accessories you use with your motorcycle and the manner in which you load your gear onto the bike might create hazards. Aerodynamics, handling, balance, and cornering clearance can suffer, and the suspension and tires can be overloaded. Read the “ACCESSORY USE AND MOTORCYCLE LOADING” section.

CARRYING A PASSENGER

Carrying a passenger, when done correctly, is a great way to share the joy of motorcycling. You will have to alter your riding style somewhat since the extra weight of a passenger will affect handling and braking. You may also need to adjust tire pressures and suspension; please refer to the Tire Pressure and Loading section and the Suspension section for more details.

A passenger needs the same protection that you do, including a helmet and proper clothing. The passenger should not wear long shoe laces or loose pants that could get caught in the wheel or the chain. Passengers must be tall enough that their feet reach the footrests.

MOTORCYCLE SAFETY FOUNDATION'S "RIDING TIPS AND PRACTICE GUIDE" HANDBOOK (FOR OWNERS IN USA)

This special handbook, supplied with your owner's manual, contains a variety of safety tips, helpful hints, and practice exercises. This manual can increase your riding enjoyment and safety. You should read it thoroughly.

BE STREET SMART

Always heed speed limits, local laws, and the basic rules of the road. Set a good example for others by demonstrating a courteous attitude and a responsible riding style.

CONCLUSION

Traffic, road and weather conditions vary. Other motorists' actions are unpredictable. Your motorcycle's condition can change. These factors can best be dealt with by giving every ride your full attention.

Circumstances beyond your control could lead to an accident. You need to prepare for the unexpected by wearing a helmet and other protective gear, and learning emergency braking and swerving techniques to minimize the damage to you and your machine.

The best way to learn basic riding skills and evasive maneuvers or refresh your own riding skills is to take one of the courses offered by the Motorcycle Safety Foundation. Your Suzuki dealer can help you locate the fundamental or advanced riding skills course nearest you, or owners in the USA can call toll-free 1-800-446-9227.

Good riding on your new Suzuki !

FUEL, ENGINE OIL AND COOLANT RECOMMENDATIONS

FUEL	2-2
ENGINE OIL	2-3
ENGINE COOLANT SOLUTION	2-5

FUEL, ENGINE OIL AND COOLANT RECOMMENDATIONS

FUEL

Your motorcycle requires regular unleaded gasoline with a minimum pump octane rating of 87 ((R+M)/2 method). In some areas, the only fuels that are available are oxygenated fuels.

Oxygenated fuels which meet the minimum octane requirement and the requirements described below may be used in your motorcycle without jeopardizing the New Vehicle Limited Warranty or the Emission Control System Warranty.

NOTE: Oxygenated fuels are fuels which contain oxygen-carrying additives such as MTBE or alcohol.

Gasoline Containing MTBE

Unleaded gasoline containing MTBE (Methyl Tertiary Butyl Ether) may be used in your motorcycle if the MTBE content is not greater than 15%. This oxygenated fuel does not contain alcohol.

Gasoline/Ethanol Blends

Blends of unleaded gasoline and ethanol (grain alcohol), also known as "GASOHOL", may be used in your vehicle if the ethanol content is not greater than 10%.

Gasoline/Methanol Blends

Fuels containing 5% or less methanol (wood alcohol) may be suitable for use in your motorcycle if they contain co-solvents and corrosion inhibitors.

DO NOT USE fuels containing more than 5% methanol under any circumstances. Fuel system damage or motorcycle performance problems resulting from the use of such fuels are not the responsibility of Suzuki and may not be covered under the New Vehicle Limited Warranty or the Emission Control System Warranty.

Fuel Pump Labeling

In some states, pumps that dispense oxygenated fuels are required to be labeled for the type and percentage of oxygen, and whether important additives are present. Such labels may provide enough information for you to determine if a particular blend of fuel meets the requirements listed above. In other states, pumps may not be clearly labeled as to the content or type of oxygen and additives. If you are not sure that the fuel you intend to use meets these requirements, check with the service station operator or the fuel supplier.

NOTE:

- To help minimize air pollution, Suzuki recommends that you use oxygenated fuels.
- Be sure that any oxygenated fuel you use has octane ratings of at least 87 pump octane ((R+M)/2 method).
- If you are not satisfied with the driveability or fuel economy of your motorcycle when you are using an oxygenated fuel, or if engine pinging is experienced, substitute another brand as there are differences between brands.

CAUTION

Spilled gasoline containing alcohol can harm your motorcycle. Alcohol can damage painted surfaces.

Be careful not to spill any fuel when filling the fuel tank. Wipe spilled gasoline up immediately.

ENGINE OIL

Oil quality is a major contributor to your engine's performance and life. Always select good quality engine oil. Suzuki recommends the use of SUZUKI PERFORMANCE 4 MOTOR OIL or equivalent engine oil. Use oil with an API (American Petroleum Institute) classification of SF/SG or SH/SJ, or with a JASO classification of MA.

SAE	API	JASO
10W-40	SF or SG	—
10W-40	SH or SJ	MA

API: American Petroleum Institute
JASO: Japanese Automobile Standards Organization

SAE Engine Oil Viscosity

Suzuki recommends the use of SAE 10W-40 engine oil. If SAE 10W-40 engine oil is not available, select an alternative according to the following chart.

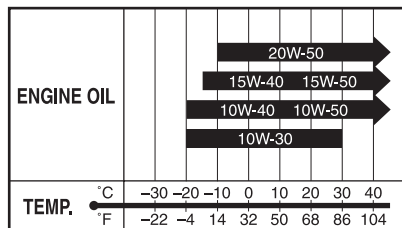

JASO T903

The JASO T903 standard is an index to select engine oils for 4-stroke motorcycle and ATV engines. Motorcycle and ATV engines lubricate clutch and transmission gears with engine oil. JASO T903 specifies performance requirements for motorcycle and ATV clutches and transmissions.

There are two classes, MA and MB. The oil container shows the classification as follows.

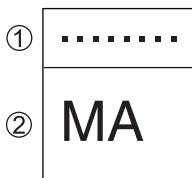

- ① Code number of oil sales company
- ② Oil classification

Energy Conserving

Suzuki does not recommend the use of “ENERGY CONSERVING” oils. Some engine oils which have an API classification of SH or higher have an “ENERGY CONSERVING” indication in the API classification doughnut mark. These oils can affect engine life and clutch performance.

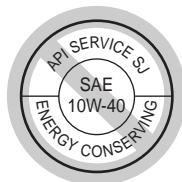

Not recommended



Recommended

ENGINE COOLANT SOLUTION

Use engine coolant that is compatible with an aluminum radiator, mixed with distilled water at a 50:50 mixture ratio for engine coolant solution. An engine coolant mixture other than 50:50 can affect cooling efficiency or rust inhibiting performance.

Engine Coolant

Engine coolant should be used at all times in your motorcycle's radiator, even if the temperature in your area does not go down to the freezing point. Engine coolant acts as a rust inhibitor and water pump lubricant as well as an anti-freeze solution.

WARNING

Engine coolant is harmful or fatal if swallowed or inhaled.

Do not drink antifreeze or coolant solution. If swallowed, do not induce vomiting. Immediately contact a poison control center or a physician. Avoid inhaling mist or hot vapors; if inhaled, remove to fresh air. If coolant gets in eyes, flush eyes with water and seek medical attention. Wash thoroughly after handling. Solution can be poisonous to animals. Keep out of the reach of children and animals.

CAUTION

Spilled engine coolant can damage painted surfaces.

Do not spill any fluid when filling the radiator. Wipe spilled engine coolant up immediately.

Water for Mixing

Use distilled water only. Water other than distilled water can corrode and clog the aluminum radiator.

Required amount of engine coolant/water solution capacity (total): 1900 ml (2.0 US qt)

Engine coolant	950 ml (1.0 US qt)
Water	950 ml (1.0 US qt)



CONTROLS, EQUIPMENT AND ADJUSTMENTS

LOCATION OF PARTS	3-2
KEY	3-5
IGNITION SWITCH	3-5
INSTRUMENT PANEL	3-7
LEFT HANDLEBAR	3-14
RIGHT HANDLEBAR	3-15
FUEL TANK CAP	3-18
GEARSHIFT LEVER	3-19
REAR BRAKE PEDAL	3-19
SEAT LOCK	3-20
HELMET HOLDER	3-20
SIDE STAND	3-21
SUSPENSION ADJUSTMENT	3-22
WINDSHIELD HEIGHT ADJUSTMENT	3-24

CONTROLS, EQUIPMENT AND ADJUSTMENTS

LOCATION OF PARTS

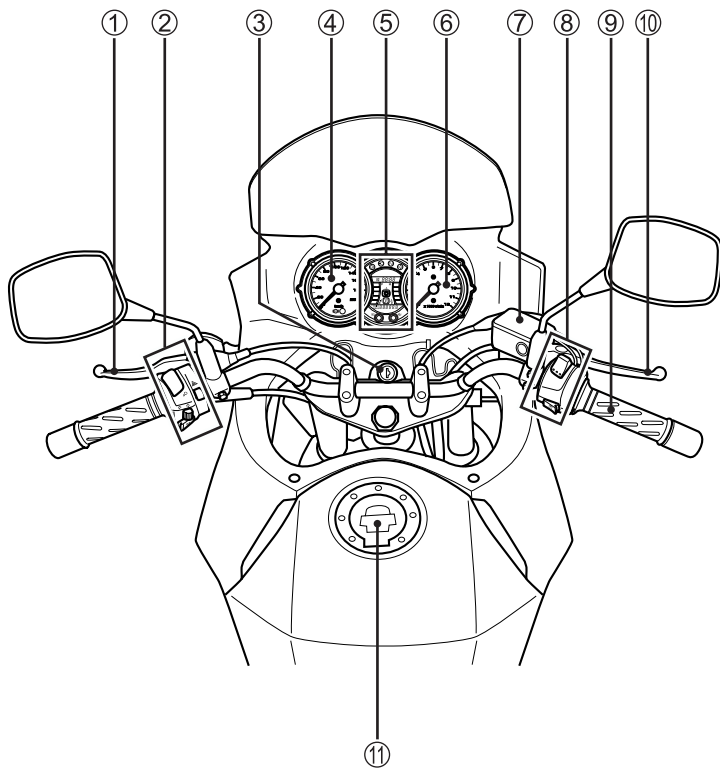

- ① Clutch lever
- ② Left handlebar switches
- ③ Ignition switch
- ④ Speedometer
- ⑤ Indicator lights
- ⑥ Tachometer
- ⑦ Front brake fluid reservoir
- ⑧ Right handlebar switches
- ⑨ Throttle grip
- ⑩ Front brake lever
- ⑪ Fuel tank cap

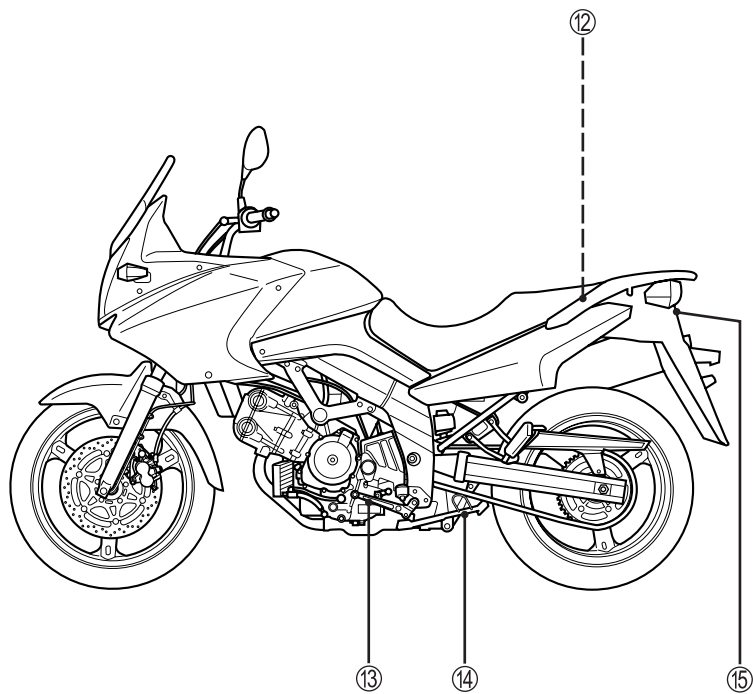

- ⑫ Tools
- ⑬ Gearshift lever
- ⑭ Side stand
- ⑮ Seat lock

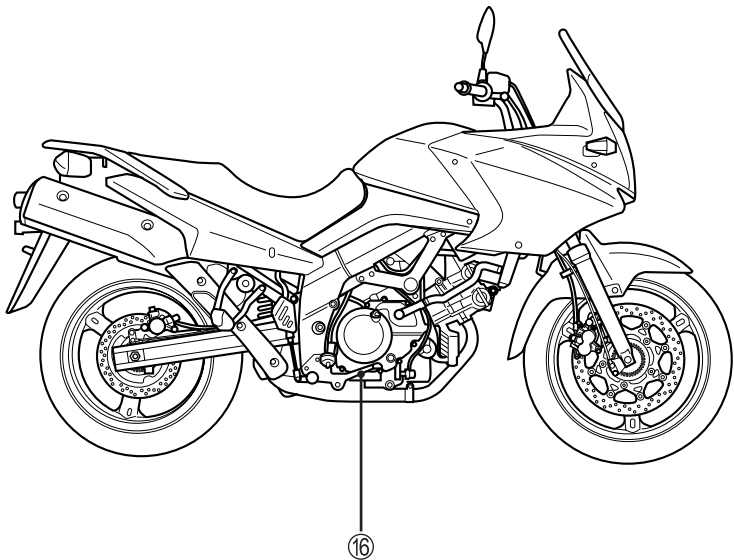

⑩ Rear brake pedal

KEY

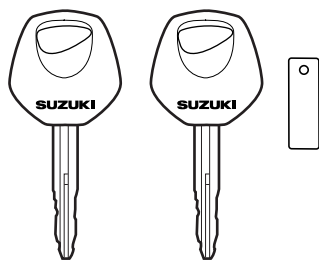

Two keys come with this motorcycle. Keep the spare key in a safe place. An identifying number is stamped on the plate. Use this number when making a replacement key.

Please write down your key number in the box provided for your future reference.

Key No.

IGNITION SWITCH

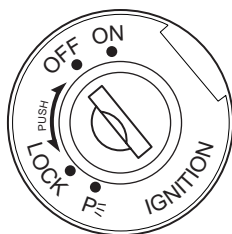

The ignition switch has 4 positions.

“OFF” position

All electrical circuits are off. The engine will not start. The key can be removed.

“ON” position

The ignition circuit is completed and the engine can run. The headlight and taillight will automatically turn on. The key cannot be removed in this position.

NOTE: Start the engine promptly after turning the key to the “ON” position, or the battery will lose power due to consumption by the headlight and taillight.

“LOCK” position

All electrical circuits are off. The key can be removed and the steering will be locked. Turn the steering all the way to the left and push down the key and turn it to the “LOCK” position.

“P” (PARKING) position

The taillight will come on to increase visibility for temporary road side parking at night. The key can be removed and the steering will be locked.

⚠ WARNING

Turning the ignition switch to the “P” (PARKING) or “LOCK” position while the motorcycle is moving can be hazardous. Moving the motorcycle while the steering is locked can be hazardous. You could lose your balance and fall, or you could drop the motorcycle.

Stop the motorcycle and place it on the side stand before locking the steering. Never attempt to move the motorcycle when the steering is locked.

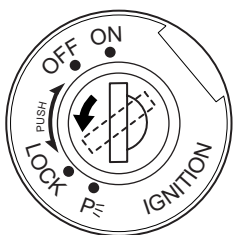

The key hole can be covered by turning the lid.

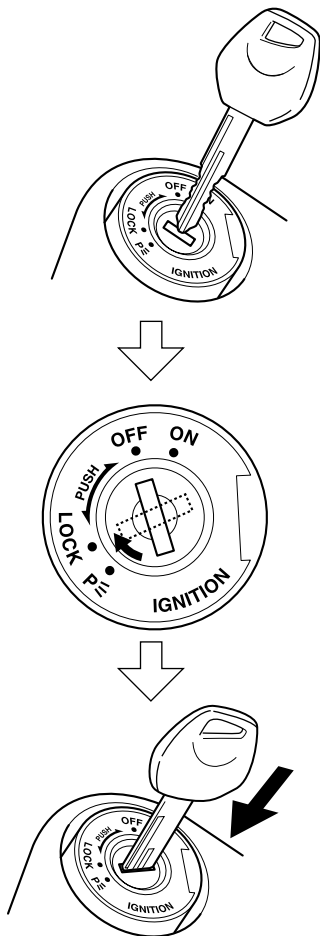

Align the lid hole position with the key hole position when inserting the key.

INSTRUMENT PANEL

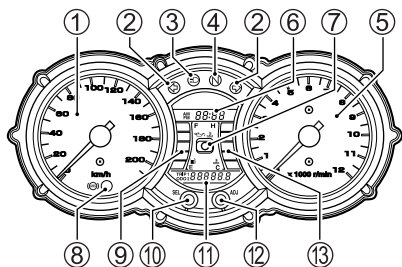

When the ignition switch is turned to the “ON” position, the speedometer and tachometer needles move to the full scale position and return to the home position. LCD displays all segments for 3 seconds when the ignition switch is turned to the “ON” position to confirm display function.

If the speedometer and tachometer needle does not point to zero, follow the procedure below to reset the speedometer and tachometer.

1. Press the ADJ button ⑫ and turn on the ignition switch.
2. Press and hold the ADJ button ⑫ for 3 – 5 seconds.
3. Release the ADJ button. Press the ADJ button twice within 1 second.

NOTE: Reset procedure, from step 1 to step 3, should be performed within 10 seconds.

Speedometer ①

The speedometer indicates the road speed in miles per hour and/or kilometers per hour.

Turn Signal Indicator Light

“↔” ②

When the turn signals are being operated either to the right or to the left, the indicator will flash at the same time.

NOTE: If a turn signal light is not operating properly due to bulb filament or circuit failure, the indicator light flickers more quickly to notify the rider of the existence of a trouble.

High Beam Indicator Light “≡▷”

③

This blue indicator light will be lit when the headlight high beam is turned on.

Neutral Indicator Light “N” ④

The green light will come on when the transmission is in neutral. The light will go out when you shift into any gear other than neutral.

Tachometer ⑤

The tachometer indicates the engine speed in revolutions per minute (r/min).

CAUTION

Riding the motorcycle with the display indicating a problem of the fuel injection system and with the indicator light lit can damage the engine and transmission.

Whenever the red indicator light is lit and the display indicates "FI", have your authorized Suzuki dealer or a qualified mechanic inspect the fuel injection system as soon as possible.

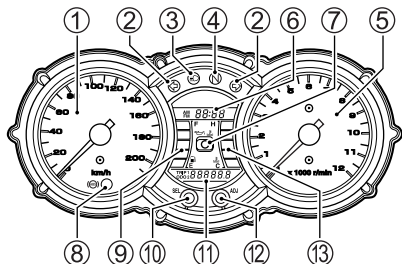

Fuel Injection System Indicator "FI"/Clock ⑥

FI

If the fuel injection system fails, the red indicator light ⑦ comes on and the display ⑥ indicates "FI" in following two modes;

- A. The display ⑥ indicates "FI" and the clock alternately, and the red indicator light ⑦ comes on and remains lit.
- B. The display ⑥ indicates "FI" continuously and the red indicator light ⑦ blinks.

The engine may continue to run in mode A, but mostly the engine will not run in mode B.

NOTE: If the display indicates "FI" and the clock alternately, and the red indicator light comes on and remains lit, keep the engine running and bring your motorcycle to an authorized Suzuki dealer. If the engine stalls, try restarting the engine after turning the ignition switch off and on.

CHEC

When the display ⑥ indicates “CHEC”, check following items;

- Make sure that the engine stop switch is in the “ Ω ” position.
- Make sure that the transmission is in neutral or the side stand is fully up.

If the display still indicates “CHEC” after checking the above items, inspect the ignition fuse and the connection of the lead wire couplers.

NOTE: The coolant temperature meter indicates “H” when the display shows “CHEC”.

Clock

AM 00:00
PM 00:00

The clock has a 12-hour display. Follow the procedure below to adjust the clock.

1. Push the buttons, SEL ⑩ and ADJ ⑫, simultaneously for 2 seconds until the minute display blinks.
2. Adjust the minute display by pushing the “ADJ” button ⑫.

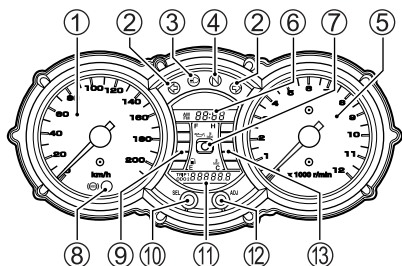

NOTE: When the “ADJ” button ⑫ is held in the display advances continuously.

3. Push the “SEL” button ⑩ to highlight the hour display.
4. Adjust the hour display by pushing the “ADJ” button ⑫.
5. Push the “SEL” button ⑩ to return to the clock mode.



Oil Pressure Indicator Light

“” ⑦

With the ignition switch in the “ON” position but the engine is not started, the symbol “” in the display and the indicator light ⑦ comes on. As soon as the engine is started, the symbol “” and the indicator light should go out.

When the engine oil pressure drops under the normal operating range, the symbol “” in the display appears and the indicator light ⑦ comes on.

CAUTION

Riding the motorcycle when the symbol “” appears and the indicator light lit can damage the engine and transmission.

Whenever the symbol “” appears and the indicator lights up, indicating low oil pressure, stop the engine immediately. Check the oil level and make sure the proper amount of oil is in the engine. If the light still does not go out, have your authorized Suzuki dealer or a qualified mechanic troubleshoot your motorcycle.

ABS Indicator Light “” ⑧

This indicator normally comes on when the ignition switch is turned “ON” and goes off after the motorcycle speed exceeds 5 km/h (3 mph).

If there is a problem with the ABS (Anti-lock Brake System), this indicator light blinks or comes on. The ABS does not operate when the ABS indicator light is on or blinking and the brake system will work as normal brakes.

NOTE: If the ABS indicator light goes off before starting the motorcycle, check the ABS indicator light function by turning off and on the ignition switch. The ABS indicator light can go off if the engine is revved at high speed before starting the motorcycle. If the ABS indicator light does not come on when the ignition switch is turned on, you should have the system checked by an authorized SUZUKI dealer as soon as possible.

WARNING



















Riding the motorcycle with the ABS indicator light on can be hazardous.

If the ABS indicator light blinks or comes on while riding, stop the motorcycle in a safe place and turn off the ignition switch. Turn the ignition switch "ON" after a while and check if the indicator light comes on.

- If the indicator light goes off a after starting to ride, the ABS will be functioning.
- If it does not go off after starting to ride, ABS is not functioning, and the brakes provide normal stopping ability. You should have the system checked by an authorized SUZUKI dealer as soon as possible.

Fuel Meter ⑨

The fuel meter indicates the amount of fuel remaining in the fuel tank. The fuel meter displays all 5 segments when the fuel tank is full. The mark flickers when the fuel level drops below 4.5 L (4.8 US qt). The mark and segment flicker when the fuel drops below 3.0 L (3.2 US qt).

Fuel tank	Approximately 3.0 L	Approximately 4.5 L	Full
Fuel gauge	     Flicker	     Flicker	    
 Mark			

NOTE: The fuel meter will not indicate correctly when the motorcycle is placed with the side stand.

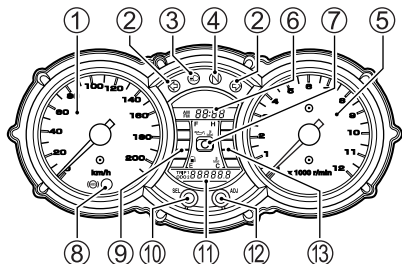

Odometer/Trip Meter ⑪

This display has 3 functions; odometer and two trip meters. When the ignition switch is turned to the “ON” position, the display indicates the test pattern shown below for 3 seconds. Then the display changes to odometer or trip meter, according to what was selected before turning the ignition switch off.



Odometer

The odometer registers the total distance that the motorcycle has been ridden.

Trip Meter

The two trip meters are resettable odometers. They can register two kinds of distance at the same time. For instance, trip meter 1 can register the trip distance and trip meter 2 can register the distance between fuel stops.

To change the display, push the “SEL” button ⑩. The display changes in the order below.

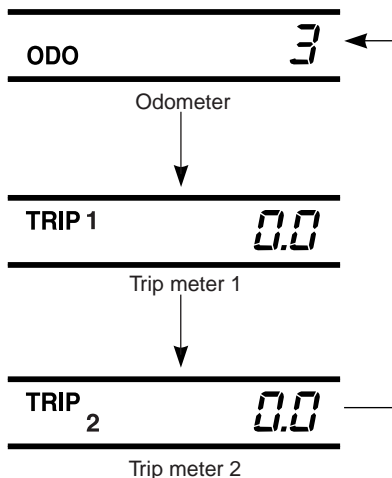

To reset the trip meter to zero, push the “ADJ” button ⑫ for two seconds while the display indicates the trip meter 1 or 2 you want to reset.

⚠ WARNING

Operating the display while riding can be hazardous. Removing a hand from the handlebars can reduce your ability to control the motorcycle.

Always keep both hands on the handlebars while riding.

Coolant Temperature Meter

“” ⑬

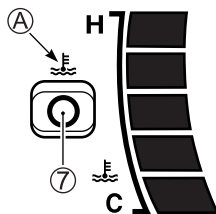

The coolant temperature meter indicates engine coolant temperature. When the coolant temperature becomes high, the mark ① and indicator light ⑦ come on.

CAUTION

Running the engine with high temperature engine coolant can cause serious engine damage. If the mark and indicator light come on, stop the engine to let it cool.

Do not run the engine until the mark and indicator light go off.

LEFT HANDLEBAR

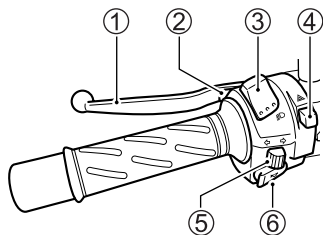

Clutch Lever ①

The clutch lever is used for disengaging the drive to the rear wheel when starting the engine or shifting transmission gears. Squeezing the lever disengages the clutch.

Headlight Flasher Switch ②

Press the switch to flash the headlight. The headlight high beam will be lit when the dimmer switch is in “” position.

Dimmer Switch ③





“” position

The headlight low beam and tail-light turn on.

“” position

The headlight high beam and tail-light turn on. The high beam indicator light also turns on.

CAUTION

Holding the dimmer switch between “” and “” position will light both “” and “” headlight beam. This operation can damage the motorcycle.

Use the dimmer switch only at “” or “” position.

CAUTION



Sticking some tape or placing objects in front of the headlight can damage the headlight.

Do not stick any tapes to the headlight. Do not place objects in front of the headlight.

Hazard Warning Switch “” ④

All four turn signal lights and indicators will flash simultaneously when the switch is turned on with the ignition switch in the “ON” or “P” position. Use the hazard warning lights to warn other traffic during emergency parking or when your vehicle could otherwise become a traffic hazard.

Turn Signal Switch “” ⑤

Moving the switch to the “” position will flash the left turn signals. Moving the switch to the “” position will flash the right turn signals. The indicator light will also flash intermittently. To cancel turn signal operation, push the switch in.

WARNING

Failure to use the turn signals, and failure to turn off the turn signals can be hazardous. Other drivers may misjudge your course and this may result in an accident.

Always use the turn signals when you intend to change lanes or make a turn. Be sure to turn off the turn signals after completing the turn or lane change.

Horn Button “” ⑥

Press the button to sound the horn.

RIGHT HANDLEBAR

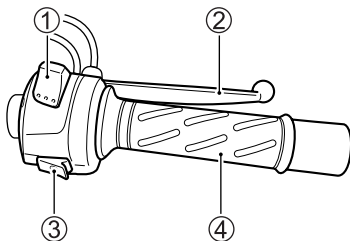

Engine Stop Switch ①

“” position

The ignition circuit is off. The engine cannot start or run.

“” position

The ignition circuit is on and the engine can run.

Front Brake Lever ②

Apply the front brake by squeezing the front brake lever towards the grip. The brake light will come on when the lever is squeezed.

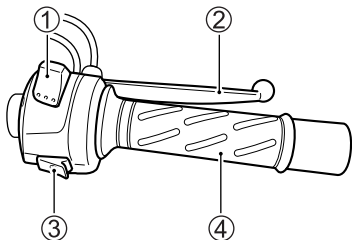

Electric Starter Button “” ③

Use this button to operate the starter motor. With the ignition switch in the “ON” position, the engine stop switch in the “” position, and the transmission in neutral, pull in the clutch lever and push the electric starter button to start the engine.

NOTE: This motorcycle has a starter interlock system for the ignition and starter circuit. The engine can only be started if:

- *The transmission is in neutral and the clutch is disengaged, or*
- *The transmission is in gear, the side stand is fully up, and the clutch is disengaged.*

NOTE: The headlight will go off when the electric starter button is pushed.

CAUTION

To prevent electrical system damage, do not operate the starter longer than five seconds at a time.

If the engine does not start after several attempts, check the fuel supply and ignition system. Refer to the TROUBLESHOOTING section in this manual.

Throttle Grip ④

Engine speed is controlled by the position of the throttle grip. Turn it toward you to increase engine speed. Turn it away from you to decrease engine speed.

Front Brake Lever Adjustment

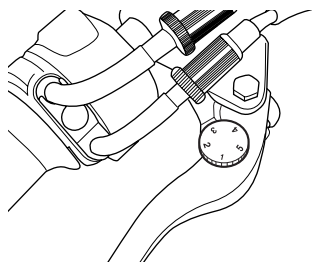

The distance between the throttle grip and the front brake lever is adjustable to 5 positions. To change the position, push the brake lever forward and turn the adjuster to the desired position. Be sure the adjuster stops in the proper position; a projection of the brake lever holder should fit into the depression of the adjuster. This motorcycle is delivered from the factory with its adjuster set on position 3.

⚠ WARNING

Adjusting the front brake lever position while riding can be hazardous. Removing a hand from the handlebars can reduce your ability to control the motorcycle.

Always keep both hands on the handlebars while riding.

FUEL TANK CAP

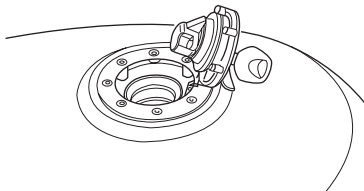
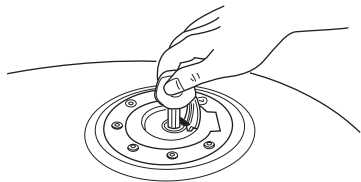

To open the fuel tank cap, insert the ignition key into the lock and turn it clockwise. With the key inserted, lift up the cap. To close the cap, push the cap down firmly with the key in the cap lock.

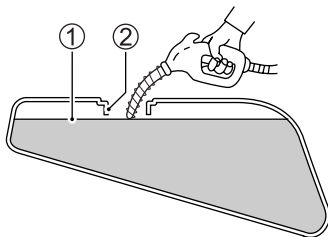

- ① Fuel level
- ② Filler neck

⚠ WARNING

Overfilling the fuel tank can cause the fuel to overflow when it expands due to heat from the engine or the sun. Spilled fuel can catch on fire.

Never fill the fuel above the bottom of the filler neck.

⚠ WARNING

Fuel and fuel vapor are highly flammable and toxic. You can be burned or poisoned when refueling.

- Stop the engine and keep flames, sparks and heat sources away.
- Refuel only outdoors or in a well ventilated area.
- Do not smoke.
- Wipe up spills immediately.
- Avoid breathing fuel vapor.
- Keep children and pets away.

GEARSHIFT LEVER

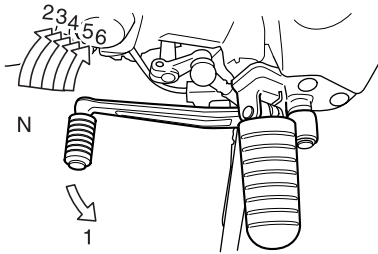

This motorcycle has a 6-speed transmission which operates as shown. To shift properly, squeeze the clutch lever and close the throttle at the same time you operate the gearshift lever. Lift the gearshift lever to upshift and depress the lever to downshift. Neutral is located between 1st and 2nd gear. When neutral is desired, depress or lift the lever halfway between 1st and 2nd gear.

NOTE: When the transmission is in neutral the green indicator light on the instrument panel will be lit. However, even though the light is illuminated, cautiously and slowly release the clutch lever to make sure that the transmission is positively in neutral.

Reduce the motorcycle speed before down-shifting. When down-shifting, the engine speed should be increased before the clutch is engaged. This will prevent unnecessary wear on the drive train components and the rear tire.

REAR BRAKE PEDAL

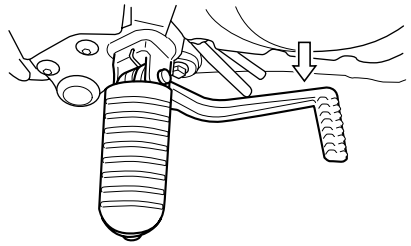

Pressing the rear brake pedal will apply the rear brake. The brake light will come on when the rear brake is operated.

SEAT LOCK

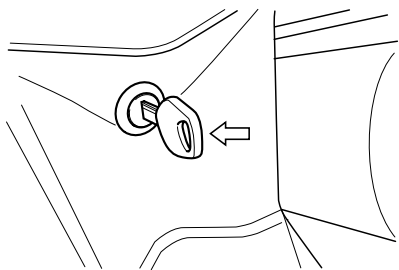

To remove the seat, insert the ignition key into the lock and turn it clockwise. Raise the rear end of the seat and slide it backward.

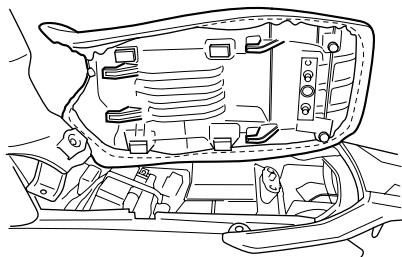

To reinstall the seat, slide the seat hooks into the seat hook retainers and push down firmly until the seat snaps into the locked position.

⚠ WARNING

Failure to install the seat properly could allow the seat to move and cause loss of rider control.

Latch the seat securely in its proper position.

A small and light article such as rain gear or a windbreaker can be placed under the seat.

Loading limit: 2 kg (4.5 lbs)

HELMET HOLDER

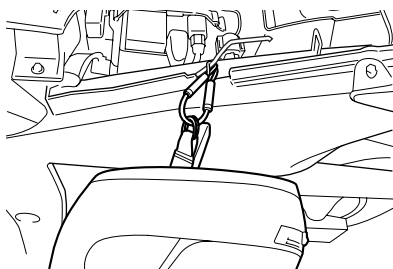
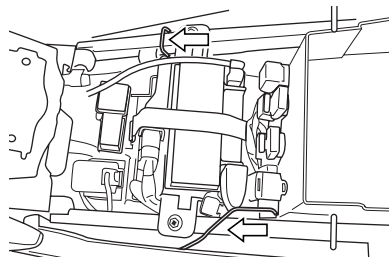

Use helmet holder wire as shown to hook the helmet.

⚠ WARNING

Riding with a helmet fastened to the helmet holder can interfere with rider control.

Never carry a helmet fastened to a helmet holder. Fix the helmet securely atop the seat if you must carry it.

SIDE STAND

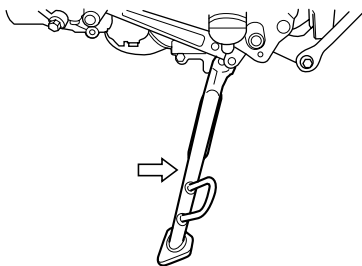

An interlock system is provided to cut off the ignition circuit when the side stand is down and the transmission is in any gear other than neutral.

The side stand/ignition interlock system works as follows:

- If the side stand is down and the transmission is in gear, the engine cannot be started.
- If the engine is running and the transmission is shifted into gear with the side stand down, the engine will stop running.
- If the engine is running and the side stand is put down with the transmission in gear, the engine will stop running.

▲ WARNING

Riding with the side stand incompletely retracted can result in an accident when you turn left.

- Check operation of the side stand/ignition interlock system before riding.
- Always retract the side stand completely before starting off.

CAUTION

Park the motorcycle on firm, level ground to help prevent it from falling over.

If you must park on an incline, put the front of the motorcycle toward uphill and put the transmission into 1st gear to reduce the possibility of rolling off the side stand.

SUSPENSION ADJUSTMENT

The standard settings for both front and rear suspensions are selected to meet various riding conditions such as low to high motorcycle speed and light to heavy load on the motorcycle. The suspension settings can be adjusted to fine-tune then according your preference.

FRONT SUSPENSION

Spring Pre-load Adjustment

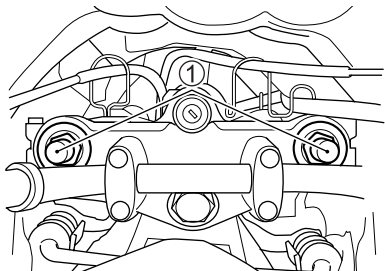

To change the spring pre-load, turn the adjuster ① clockwise or counterclockwise. Turning the adjuster clockwise will increase the spring pre-load. Turning the adjuster counterclockwise will decrease the spring pre-load. There are 5 grooved lines on the side of the adjuster ① for reference. Position 5 provides the minimum spring pre-load and position 0 provides the maximum pre-load. This motorcycle is delivered from the factory with its adjuster set on position 3.

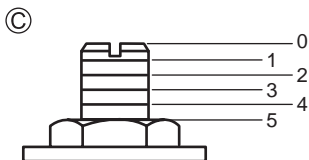
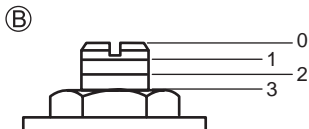

- (A) Position 0
- (B) Position 3
- (C) Position 5

⚠ WARNING

Unequal suspension adjustment can cause poor handling and loss of stability.

Adjust the right and left front forks to the same settings.

REAR SUSPENSION Spring Pre-load Adjustment

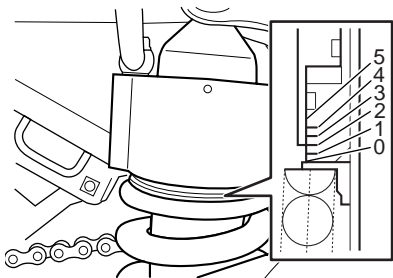
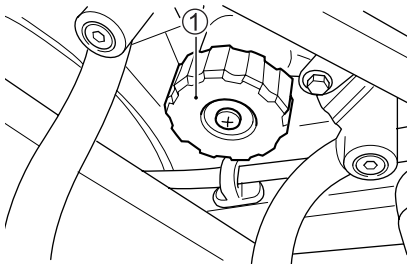

To adjust the rear suspension spring pre-load, turn the adjuster ①. Turning the adjuster clockwise will stiffen the spring pre-load and turning it counterclockwise will soften the spring pre-load. Position 0 provides the softest spring pre-load and position 5 provides the stiffest. This motorcycle is delivered from the factory with its adjuster set on position 2.

Damping Force Adjustment

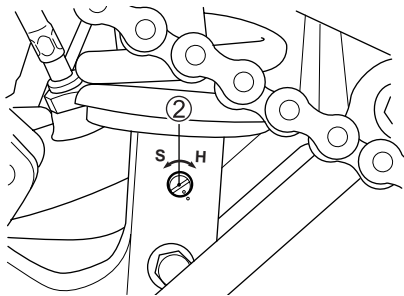

The rebound damping force adjuster ② is located at the bottom of the rear suspension damper unit. To adjust the damping force, set the adjuster to the standard setting first and then adjust it to the desired position. To set the damping force adjuster to the standard position:

1. Turn the adjuster clockwise until it stops.
2. Turn the adjuster counterclockwise 1 turn.

Turn the adjuster clockwise to stiffen the damping force and turn it counterclockwise to soften the damping force.

WINDSHIELD HEIGHT ADJUSTMENT

The windshield height can be adjusted in 3 positions. To change windshield height, follow the procedure below.

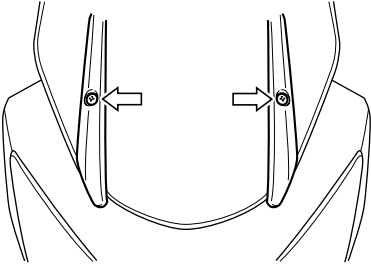

1. Remove the screws and plates.

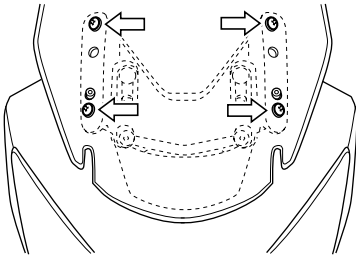

2. Remove the screws and windshield.

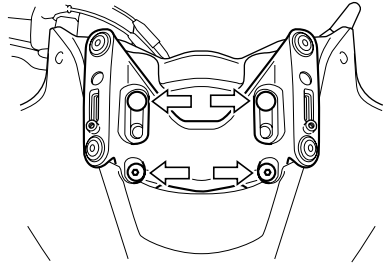

3. Remove the 4 bolts.
4. Move the windshield up and down to desired windshield height.
5. Reinstall the windshield in the reverse order of the removal.

BREAK-IN AND INSPECTION BEFORE RIDING

INSPECTION BEFORE RIDING 4-3

BREAK-IN AND INSPECTION BEFORE RIDING

The first 800 km (500 miles) is the most important in the life of your motorcycle. Proper operation during this break-in period will help assure maximum life and performance from your new motorcycle. The following guidelines explain proper break-in procedures.

Maximum Engine Speed Recommendation

The table below shows the maximum engine speed recommendation during the break-in period.

Initial 800 km (500 miles)	Below 5000 r/min
Up to 1600 km (1000 miles)	Below 7500 r/min
Over 1600 km (1000 miles)	Below 10500 r/min

Vary the Engine Speed

Vary the engine speed during the break-in period. This allows the parts to “load” (aiding the mating process) and then “unload” (allowing the parts to cool). Although it is essential to place some stress on the engine components during break-in, you must be careful not to load the engine too much.

Breaking in the New Tires

New tires need proper break-in to assure maximum performance, just as the engine does. Wear in the tread surface by gradually increasing your cornering lean angles over the first 160 km (100 miles) before attempting maximum performance. Avoid hard acceleration, hard cornering, and hard braking for the first 160 km (100 miles).

WARNING

Failure to perform break-in of the tires could cause tire slip and loss of control.

Use extra care when riding on new tires. Perform proper break-in of the tires as described in this section and avoid hard acceleration, hard cornering, and hard braking for the first 160 km (100 miles).

Allow the Engine Oil to Circulate before Riding

Allow enough idling time after warm or cold engine start-up before revving the engine or placing the transmission in gear. This allows time for the lubricating oil to reach all critical engine components.

Observe Your Initial and Most Critical Service

The initial service (break-in maintenance) is the most important service your motorcycle will receive. During break-in operation, all of the engine components will have mated together and seated. Maintenance required as part of the initial service includes correction of all adjustments, tightening of all fasteners and replacement of dirty oil. Timely performance of this service will help make sure you get the longer service life and the best performance from the engine.

INSPECTION BEFORE RIDING

⚠ WARNING

Failure to inspect and maintain your motorcycle properly increases the chance of an accident or equipment damage.

Always perform a pre-ride inspection before each ride. Refer to the table on page 4-4 for check items. For further details, refer to the INSPECTION AND MAINTENANCE section.

⚠ WARNING

Using worn, improperly inflated, or incorrect tires will reduce stability and can cause an accident.

Follow all instructions in the TIRES section in this owner's manual.

Check the condition of the motorcycle to help make sure that you do not have mechanical problems or get stranded somewhere when you ride. Before riding the motorcycle, be sure to check the following items. Be sure your motorcycle is in good condition for the personal safety of the rider, passenger and protection of the motorcycle.

WARNING

Checking maintenance items when the engine is running can be hazardous. You could be severely injured if your hands or clothing get caught in moving parts.

Shut the engine off when performing maintenance checks, except when checking the engine stop switch and throttle.

WHAT TO CHECK	CHECK FOR
Steering	<ul style="list-style-type: none"> • Smoothness • No restriction of movement • No play or looseness
Brakes	<ul style="list-style-type: none"> • Proper pedal and lever operation • Correct fluid level • No fluid leakage • No "sponginess" • Proper pedal and lever play • Brake pad wear
Tires	<ul style="list-style-type: none"> • Proper pressure • Enough tread depth • No cracks, rips, or other damage

Fuel tank	Tank cap locked securely
Lighting	Proper operation of all lights – Headlight, Taillight, Brake light, Instrument lights, Turn signals
Indicator lights	Proper operation of all indicators – Coolant temperature, Oil pressure, High beam, Neutral, Turn signal, FI, ABS
Engine stop switch	Proper operation
Horn	Correct function
Engine oil	Correct level
Cooling system	<ul style="list-style-type: none"> • Proper engine coolant level • No leaks or damage
Throttle	<ul style="list-style-type: none"> • Proper play • Smooth response • Quick return to idle position
Gearshift lever	<ul style="list-style-type: none"> • No damage • Smooth operation
Clutch	<ul style="list-style-type: none"> • Correct fluid level • No fluid leakage • No "sponginess" • Proper lever play • Smooth and progressive action
Drive chain	<ul style="list-style-type: none"> • Proper tension • Adequate lubrication • No excessive wear or damage
Side stand/ Ignition interlock system	Proper operation
General condition	<ul style="list-style-type: none"> • Bolts and nuts tightness • No rattle from any parts of machine with the engine running • No visible evidence of damage

RIDING TIPS

STARTING THE ENGINE	5-2
STARTING OFF AND SHIFTING	5-3
USING THE TRANSMISSION	5-4
RIDING ON HILLS	5-5
STOPPING AND PARKING	5-5
CARRYING A PASSENGER	5-8

RIDING TIPS

STARTING THE ENGINE

Before attempting to start the engine, make sure:

1. The transmission is in neutral.
2. The engine stop switch is in the "O" position.

NOTE: This motorcycle has interlock switches for the ignition circuit and the starter circuit. The engine can only be started if:

- *The transmission is in neutral and the clutch is disengaged, or*
 - *The transmission is in gear, the side stand is fully up, and the clutch is disengaged.*
3. Close the throttle completely and push the electric starter button.

NOTE: Open the throttle 1/8 and push the electric starter button when the engine is hard to start.

WARNING

Running the engine indoors or in a garage can be hazardous. Exhaust gas contains carbon monoxide, a gas that is colorless and odorless and can cause death or severe injury.

Only run the engine outdoors where there is fresh air.

CAUTION

Running the engine too long without riding may cause the engine to overheat. Overheating can result in damage to internal engine components and discoloration of exhaust pipes.

Shut the engine off if you cannot begin your ride promptly.

STARTING OFF AND SHIFTING

WARNING

Riding this motorcycle at excessive speed increases your chances of losing control of the motorcycle. This may result in an accident.

Always ride within the limits of your skills, your motorcycle, and the riding conditions.

WARNING

Removing your hands from the handlebars or feet from the footrests during operation can be hazardous. If you remove even one hand or foot from the motorcycle, you can reduce your ability to control the motorcycle.

Always keep both hands on the handlebars and both feet on the footrests of your motorcycle during operation.

WARNING

Sudden side winds, which can occur when being passed by larger vehicles, at tunnel exits or in hilly areas, can upset your control.

Reduce your speed and be alert to side winds.

Make sure that the side stand is in the fully up position. Squeeze the clutch lever and pause momentarily. Engage first gear by depressing the gearshift lever downward. Turn the throttle grip toward you and at the same time release the clutch lever gently and smoothly. As the clutch engages, the motorcycle will start moving forward. To shift to the next higher gear, accelerate gently, then close the throttle and squeeze the clutch lever simultaneously. Lift the gear shift lever upward to select the next gear and release the clutch lever as you open the throttle again. Select higher gears in this manner until top gear is reached.

NOTE: This motorcycle has a side stand/ignition interlock switch. If you shift the transmission into gear when the side stand is down, the engine will stop running.

USING THE TRANSMISSION

The transmission is provided to keep the engine operating smoothly in its normal operating speed range. The gear ratios have been carefully chosen to meet the characteristics of the engine. The rider should always select the most suitable gear for the prevailing conditions. Never slip the clutch to control road speed, but rather downshift to allow the engine to run within its normal operational range. The table below shows the approximate speed range for each gear.

Shifting up schedule

Gear position	km/h	miles/h
1st → 2nd	20	12
2nd → 3rd	30	19
3rd → 4th	40	25
4th → 5th	50	31
5th → 6th	60	37

Shifting down schedule

Gear position	km/h	miles/h
6th → 5th	50	31
5th → 4th	40	25
4th → 3rd	30	19

Disengage the clutch when the motorcycle speed drops below 20 km/h (12 miles/h).

WARNING

Downshifting when engine speed is too high can:

- cause the rear wheel to skid and lose traction due to increased engine braking, resulting in an accident; or
- force the engine to overrev in the lower gear, resulting in engine damage.

Reduce speed before downshifting.

WARNING

Downshifting while the motorcycle is leaned over in a corner may cause rear wheel skid and loss of control.

Reduce your speed and downshift before entering a corner.

CAUTION

Revvng the engine into the red zone can cause severe engine damage.

Never allow the engine to rev into the red zone in any gear.

RIDING ON HILLS

- When climbing steep hills, the motorcycle may begin to slow down and show lack of power. At this point you should shift to a lower gear so that the engine will again be operating in its normal power range. Shift rapidly to prevent the motorcycle from losing momentum.
- When riding down a steep hill, the engine may be used for braking by shifting to a lower gear.
- Be careful, however, not to allow the engine to overrev.

STOPPING AND PARKING

Anti-lock Brake System (ABS)

This model is equipped with an Anti-lock Brake System (ABS) designed to help prevent wheel lock up during hard braking or during braking on slippery surfaces while riding in a straight line.

The ABS will operate whenever it senses that the wheels are locking up. You may feel the brake lever pulsates lightly while the ABS is operating.

Even though ABS helps prevent wheel lock-up, you must still be careful when braking in curves. Hard braking while turning could cause wheel skidding and loss of control, whether or not your motorcycle is equipped with ABS. Having ABS does not mean you can take unnecessary risks. ABS will not compensate for poor judgment, incorrect braking techniques, or the need to slow down over bad roads or in poor weather conditions.

You must still ride sensibly and alertly.

On regular paved roads, some riders may be able to obtain slightly shorter stopping distances with conventional brake systems than with ABS.

NOTE: In some situations, a motorcycle with ABS may require a longer stopping distance to stop on loose or uneven surfaces than an equivalent motorcycle without ABS.

⚠ WARNING

Inexperienced riders tend to underutilize the front brake. This can cause excessive stopping distance and lead to a collision. Using only the front or rear brake can cause skidding and loss of control.

Apply both brakes evenly and at the same time.

⚠ WARNING

Braking while turning the motorcycle can be hazardous, whether or not your motorcycle is equipped with ABS. ABS can not control wheel's side-slips that occur when you brake hard while turning and the side-slips could cause loss of control.

Slow down sufficiently in a straight line before you begin to turn and avoid braking while turning except slight braking.

⚠ WARNING

Failure to use good judgment with ABS can be hazardous. ABS cannot make up for bad road conditions, bad judgment, or improper operation of the brakes.

Remember that ABS will not compensate for poor judgment, incorrect braking techniques, or the need to slow down over bad roads or in poor weather conditions. Use good judgment and do not ride faster than conditions will safely allow.

How the ABS Works

ABS works by electronically controlling braking pressure. A computer monitors wheel rotation speed. If the computer detects that a braked wheel has slowed suddenly, indicating a skidding situation, the computer will reduce braking pressure to prevent that wheel from locking up. ABS works automatically, so you do not need any special braking technique. Just apply the front and rear brakes, as forcefully as necessary for the situation, without pumping either one. It is normal for the brake lever/pedal to pulsate while the ABS is operating.

Non-recommended tires can affect wheel speed and may confuse the computer.

ABS does not work at very low speed, less than 10 km/h (6 mph), and does not work with the discharged battery.

Stopping and Parking

1. Turn the throttle grip away from you to close the throttle completely.
2. Apply the front and rear brakes evenly and at the same time.
3. Downshift through the gears as motorcycle speed decreases.

4. Select neutral with the clutch lever squeezed towards the grip (disengaged position) just before the motorcycle stops. The neutral position can be confirmed by observing the neutral indicator light.

WARNING

Inexperienced riders tend to underutilize the front brake. This can cause excessive stopping distance and lead to a collision. Using only the front or rear brake can cause skidding and loss of control.

Apply both brakes evenly and at the same time.

WARNING

Hard braking while turning may cause wheel skid and loss of control.

Brake before you begin to turn.

WARNING

Hard braking on wet, loose, rough, or other slippery surfaces can cause wheel skid and loss of control.

Brake lightly and with care on slippery or irregular surfaces.

WARNING

Following another vehicle too closely can lead to a collision. As vehicle speeds increase, stopping distance increases progressively.

Be sure you have a safe stopping distance between you and the vehicle in front of you.

5. Park the motorcycle on a firm, flat surface where it will not fall over.

WARNING

A hot muffler can burn you. The muffler will be hot enough to burn you for some time after stopping the engine.

Park the motorcycle where pedestrians or children are not likely to touch the muffler.

6. Turn the ignition switch to the "OFF" position.
7. Turn the handlebars all the way to the left and lock the steering for security.
8. Remove the ignition key.

NOTE: If an optional anti-theft lock such as U-shape lock, brake disk lock and chain is used to avoid theft, be sure to remove anti-theft lock before moving the motorcycle.

CARRYING A PASSENGER

Before you invite someone to be a passenger on your motorcycle, you need to be thoroughly familiar with motorcycle operation. Adjust tire pressures and suspension according to the Tire Pressure and Loading section and the Suspension section of this manual.

The passenger should always hold onto your waist or hips, or onto the seat strap or grab bar, as equipped. Ask your passenger not to make any sudden movements. When you lean going around a corner, the passenger should lean with you. The passenger should always keep his or her feet on the footrests, even when you are stopped at a light.

To help prevent burn injuries, warn your passenger not to contact the muffler when mounting or dismounting your motorcycle.

ACCESSORY USE AND MOTORCYCLE LOADING

ACCESSORY USE	6-2
ACCESSORY INSTALLATION GUIDELINE	6-2
LOADING LIMIT	6-3
LOADING GUIDELINES	6-4
MODIFICATION	6-4

ACCESSORY USE AND MOTORCYCLE LOADING

ACCESSORY USE

The addition of unsuitable accessories can lead to unsafe operating conditions. It is not possible for Suzuki to test each accessory on the market or combinations of all the available accessories; however, your dealer can assist you in selecting quality accessories and installing them correctly. Use extreme caution when selecting and installing the accessories on your motorcycle and consult your Suzuki dealer if you have any questions.

WARNING

Improper accessory installation can make your motorcycle unsafe and can lead to an accident.

Use Suzuki genuine accessories or equivalent, designed and tested for your motorcycle. Follow the guidelines in this section.

ACCESSORY INSTALLATION GUIDELINE

- Install aerodynamic affecting accessories, such as a fairing, windshield, backrests, saddlebags, and travel trunks, as low as possible, as close to the motorcycle and as near to the center of gravity as is feasible. Check that the mounting brackets and other attachment hardware are rigidly mounted.
- Inspect for proper ground clearance and bank angle. Inspect that the accessory does not interfere with the operation of the suspension, steering or other control operations.
- Accessories fitted to the handlebars or the front fork area can create serious stability problems. The extra weight will cause the motorcycle to be less responsive to your steering control. The weight may also cause oscillations in the front end and lead to instability problems. Accessories added to the handlebars or front fork of the machine should be as light as possible and kept to a minimum.
- Certain accessories displace the rider from his or her normal riding position. This limits the freedom of movement of the rider and may limit control ability.

- Additional electrical accessories may overload the existing electrical system. Severe overloads may damage the wiring harness or create a hazardous situation due to the loss of electrical power during the operation of the motorcycle.
- Do not pull a trailer or sidecar. This motorcycle is not designed to pull a trailer or sidecar.

LOADING LIMIT

WARNING

Overloading or improper loading can cause loss of motorcycle control and this may result in an accident.

Follow loading limits and loading guidelines in this manual.

- Never exceed the GVWR (Gross Vehicle Weight Rating) of this motorcycle. The GVWR is the combined weight of the machine, accessories, payload, rider and passenger. When selecting your accessories, keep in mind the weight of the riders as well as the weight of the accessories. The additional weight of the accessories may not only create an unsafe riding condition but may also affect the steering ease.

GVWR: 420 kg (926 lbs) at the tire pressure (cold)

Front: 225 kPa

(2.25 kgf/cm², 33 psi)

Rear: 280 kPa

(2.80 kgf/cm², 41 psi)

LOADING GUIDELINES

This motorcycle is primarily intended to carry small items when you are not riding with a passenger. Follow the guidelines below to carry a passenger or cargo:

- Balance the load between the left and right side of the motorcycle and fasten it securely.
- Keep cargo weight low and close to the center of the motorcycle as possible.
- Do not attach large or heavy items to the handlebars, front forks or rear fender.
- Do not install a luggage carrier or a luggage box protruding over the tail end of the motorcycle.
- Do not carry any items that protrude over the tail end of the motorcycle.
- Check that both tires are properly inflated to the specified tire pressure for your loading conditions. Refer to page 7-34.
- Improperly loading your motorcycle can reduce your ability to balance and steer the motorcycle. You should ride at reduced speeds, less than 130 km/h (80 mph), when you are carrying cargo or have added accessories.
- Adjust suspension setting as necessary.

MODIFICATION

Modification of the motorcycle, or removal of original equipment may render the vehicle unsafe or illegal. Obey all applicable equipment regulations in your area.

The frame of this motorcycle is made of an aluminum alloy. Therefore, never make any modifications such as drilling or welding to the frame as it weakens the frame significantly. This could result in an unsafe vehicle operating condition and subsequent accident. Suzuki will not be responsible in any way for personal injury or damage to the motorcycle caused by frame modifications.

Bolt-on-accessories that do not modify the frame in any way may be installed, provided that the GVWR is not exceeded.

WARNING

Modification to an aluminum alloy frame, such as drilling or welding, weakens the frame. This could result in an unsafe operating condition and may lead to an accident.

Never make any modifications to the frame.

INSPECTION AND MAINTENANCE

NOTICE	7-2
MAINTENANCE SCHEDULE	7-2
TOOLS	7-5
FUEL TANK LIFT	7-5
LUBRICATION POINTS	7-7
BATTERY	7-8
AIR CLEANER	7-9
SPARK PLUG	7-12
ENGINE OIL	7-16
ENGINE IDLE SPEED INSPECTION	7-20
THROTTLE CABLE PLAY	7-21
FUEL HOSES	7-22
ENGINE COOLANT	7-22
DRIVE CHAIN	7-24
CLUTCH	7-28
BRAKES	7-29
TIRES	7-33
SIDE STAND/IGNITION INTERLOCK SYSTEM	7-36
FRONT WHEEL REMOVAL	7-37
REAR WHEEL REMOVAL	7-40
LIGHT BULB REPLACEMENT	7-42
FUSES	7-44

INSPECTION AND MAINTENANCE

NOTICE

MAINTENANCE, REPLACEMENT OR REPAIR OF THE EMISSION CONTROL DEVICES AND SYSTEMS MAY BE PERFORMED BY ANY MOTORCYCLE REPAIR ESTABLISHMENT OR INDIVIDUAL USING ANY MOTORCYCLE PART WHICH HAS BEEN CERTIFIED UNDER THE PROVISIONS IN THE CLEAN AIR ACT Sec. 207 (a)(2).

MAINTENANCE SCHEDULE

It is very important to inspect and maintain your motorcycle regularly. Follow the guidelines in the chart. The intervals between periodic services in kilometers, miles and months are shown. At the end of each interval, be sure to perform the maintenance listed.

WARNING

Improper maintenance or failure to perform recommended maintenance increases the chance of an accident or motorcycle damage.

Always follow the inspection and maintenance recommendations and schedules in this owner's manual. Ask your SUZUKI dealer or a qualified mechanic to do the maintenance items marked with an asterisk (*). You may perform the unmarked maintenance items by referring to the instructions in this section, if you have mechanical experience. If you are not sure how to do any of the jobs, have your SUZUKI dealer or a qualified mechanic do them.

WARNING

Running the engine indoors or in a garage can be hazardous. Exhaust gas contains carbon monoxide, a gas that is colorless and odorless and can cause death or severe injury.

Only run the engine outdoors where there is fresh air.

CAUTION

Using poor quality replacement parts can cause your motorcycle to wear more quickly and may shorten its useful life.

Use only genuine Suzuki replacement parts or their equivalent.

NOTE: The MAINTENANCE CHART specifies the minimum requirements for maintenance. If you use your motorcycle under severe conditions, perform maintenance more often than shown in the chart. If you have any questions regarding maintenance intervals, consult your SUZUKI dealer or a qualified mechanic.

MAINTENANCE CHART

Interval: This interval should be judged by odometer reading or number of months, whichever comes first.

Element	Interval	1000	6000	12000	18000	24000	
	km						
	miles	600	4000	7500	11000	14500	
	months	2	12	24	36	48	
Air cleaner element		–	I	I	R	I	
* Exhaust pipe bolts and muffler bolts		T	T	T	T	T	
* Valve clearance		–	–	–	–	I	
Spark plugs		–	I	R	I	R	
Fuel hose		–	I	I	I	I	
	*Replace every 4 years						
Engine oil		R	R	R	R	R	
Engine oil filter		R	–	–	R	–	
Throttle cable play		I	I	I	I	I	
* Throttle valve synchronization		I (CA. only)	–	I	–	I	
* Evaporative emission control system (California model only)		–	–	I	–	I	
	Replace vapor hose every 4 years						
* PAIR (air supply) system		–	–	I	–	I	
* Engine coolant		Replace every 2 years					
Radiator hose		–	I	I	I	I	
	Replace every 4 years						
Clutch		–	I	I	I	I	
Drive chain		I	I	I	I	I	
	Clean and lubricate every 1000 km (600 miles)						
* Brakes		I	I	I	I	I	
Brake hose		–	I	I	I	I	
	*Replace every 4 years						
Brake fluid		–	I	I	I	I	
	*Replace every 2 years						
Tires		–	I	I	I	I	
* Steering		I	–	I	–	I	
* Front forks		–	–	I	–	I	
* Rear suspension		–	–	I	–	I	
* Chassis bolts and nuts		T	T	T	T	T	

NOTE: I= Inspect and clean, adjust, replace or lubricate as necessary, R= Replace, T= Tighten

NOTE: (California model only) and (CA. only) means that the items or the maintenance interval is to be applied only for the California model.

TOOLS

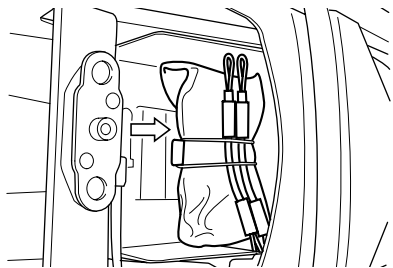

A tool kit is provided with your motorcycle. It is located under the seat.

FUEL TANK LIFT

1. Place the motorcycle on the side stand.
2. Remove the seat.

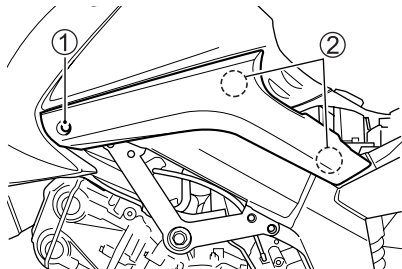

3. Remove the bolt (1) and hooks (2). Remove the covers.

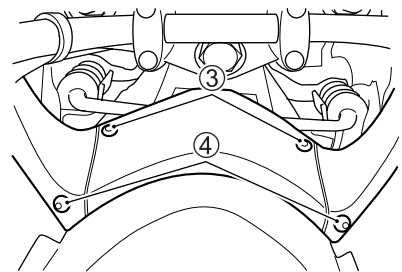

4. Remove the fasteners (3) and bolts (4).

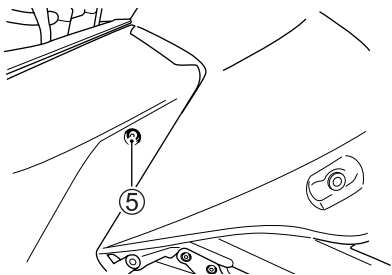

5. Remove the bolts ⑤.

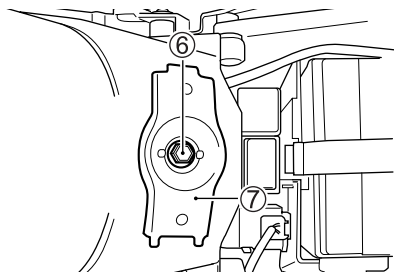

6. Remove the bolt ⑥. Remove the prop ⑦.

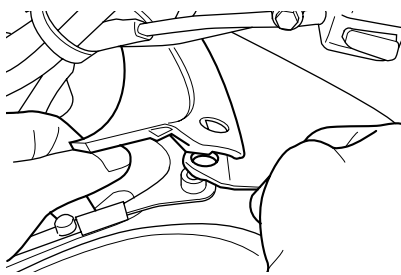

7. Raise the covers with hand to separate the covers.

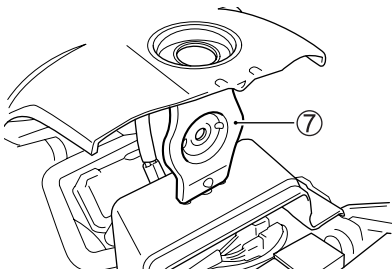

8. Support the fuel tank with the prop ⑦.

LUBRICATION POINTS

Proper lubrication is important for safe, smooth operation and a long life for your motorcycle. Be sure that all lubrication is performed during periodic maintenance on the motorcycle. Increase frequency when you use your motorcycle in severe conditions.

CAUTION

Lubricating switches can damage the switches.

Do not apply grease and oil to the switches.

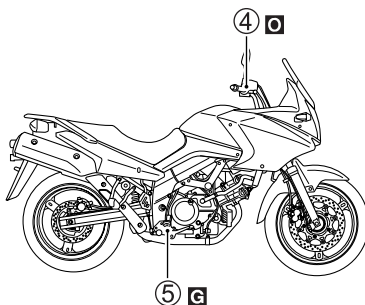
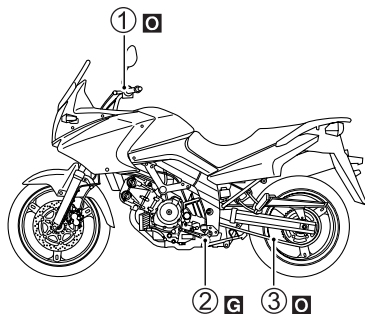

Ⓞ.... Motor oil

Ⓜ.... Grease

- ①.... Clutch lever holder
- ②.... Side stand pivot and spring hook
- ③.... Drive chain
- ④.... Throttle cable and brake lever holder
- ⑤.... Brake pedal pivot and footrest pivot

BATTERY

The battery is located under the seat. This battery is a sealed type battery and requires no maintenance. Have your dealer check the battery's state of charge periodically. The standard charging rate in $1.2A \times 5 - 10$ hours and the maximum rate is $5A \times 1$ hour.

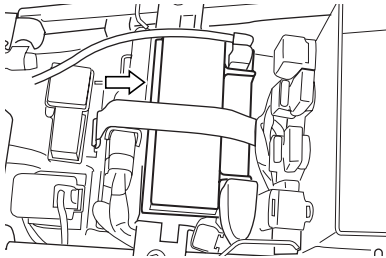

⚠ WARNING

Battery posts, terminals, and related accessories contain lead and lead compounds.

Wash hands after handling.

⚠ WARNING

Hydrogen gas produced by batteries can explode if exposed to flames or sparks.

Keep flames and sparks away from the battery. Never smoke when working near the battery.

CAUTION

Exceeding the maximum charging rate for the battery can shorten its life.

Never exceed the maximum charging rate.

CAUTION

Reversing the battery lead wires can damage the charging system and the battery.

The red lead must go to the positive (+) terminal and the black (or black with white tracer) lead must go to the negative (-) terminal.

AIR CLEANER

The air cleaner element must be kept clean to provide good engine power and gas mileage. If you use your motorcycle under normal low-stress conditions, you should service the air cleaner at the intervals specified. If you ride in dusty, wet, or muddy conditions, you will need to inspect the air cleaner element much more frequently. Use the following procedure to remove the element and inspect it.

WARNING

Operating the engine without the air cleaner element in place could allow a flame to spit back from the engine to the air cleaner, or could allow dirt to enter the engine. This could cause a fire or severe engine damage.

Never run the engine without the air cleaner element properly installed.

CAUTION

Clean or replace the air cleaner element frequently if the motorcycle is used in dusty, wet or muddy conditions. The air cleaner element will clog under these conditions, and this may cause engine damage, poor performance, and poor fuel economy.

Clean the air cleaner case and element immediately if water gets in the air cleaner box.

Air Cleaner Element Removal

1. Lift the fuel tank by referring to the FUEL TANK LIFT section.

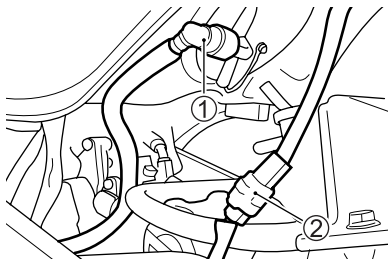

2. Disconnect the fuel hose (1) and coupler (2).

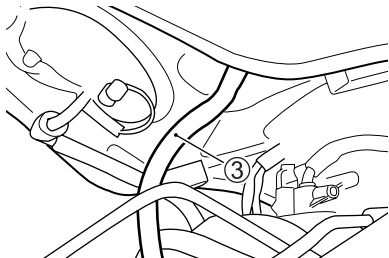

3. Disconnect the hose (3).

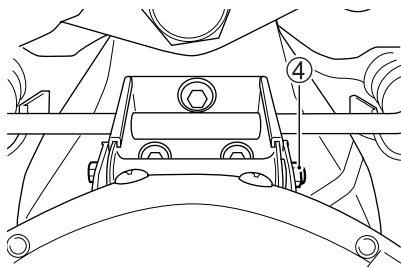

4. Remove the nut (4) and bolt.
5. Remove the fuel tank.

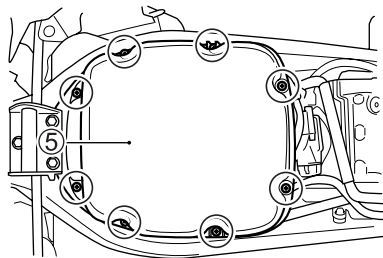

6. Remove the screws.
7. Pull up the air cleaner cover (5).

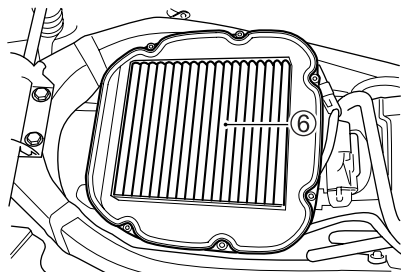

8. Remove the air cleaner element (6).

Air Cleaner Element Cleaning

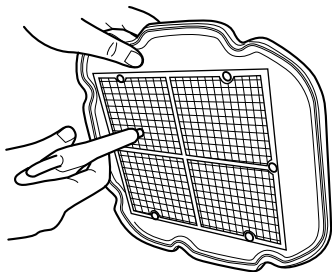

Carefully use an air hose to blow the dust from the air cleaner element.

NOTE: Always apply air pressure to the mesh side of the air cleaner element only. If you apply air pressure to the fabric side, dirt will be forced into the pores of the element, restricting the air flow through the element.

Installation

Reinstall the air cleaner element in the reverse order of the removal.

CAUTION

A torn air cleaner element will allow dirt to enter the engine and can damage the engine.

Carefully examine the air cleaner element for tears during cleaning. Replace it with a new one if it is torn.

CAUTION

Failure to position the air cleaner element properly can allow dirt to bypass the air cleaner element. This will cause engine damage.

Be sure to properly install the air cleaner element.

SPARK PLUG

Your motorcycle comes equipped with NGK CR8E or DENSO U24ESR-N spark plugs. To determine if the standard spark plug is right for your usage, check the color of the plug's porcelain center electrode insulator after motorcycle operation. A light brown color indicates that the plug is correct. A white or dark insulator indicates that the engine may need adjustment, or another plug type may be needed. Consult your Suzuki dealer or a qualified mechanic if your plug insulator is not a light brown color.

CAUTION

An improper spark plug may have an incorrect fit or heat range for your engine. This may cause severe engine damage which will not be covered under warranty.

Use one of the spark plugs listed below or a equivalent. Consult your Suzuki dealer or a qualified mechanic if you are not sure which spark plug is correct for your type of usage.

Plug Replacement Guide

NGK	DENSO	REMARKS
CR7E	U22ESR-N	If the standard plug's insulator is dark, replace with this plug.
CR8E	U24ESR-N	Standard
CR9E	U27ESR-N	If the standard plug's insulator is white, replace with this plug.

NOTE: If the above-named plugs are not available, consult your Suzuki dealer.

NOTE: This motorcycle uses resistor-type spark plug to avoid jamming electronic parts. Improper spark plug selection may cause electronic interference with your motorcycles' ignition system, resulting in motorcycle performance problems. Use only the recommended spark plugs.

SPARK PLUG REMOVAL

To remove the spark plugs, follow the procedure below:

Front Side

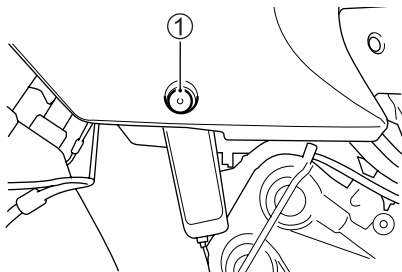

1. Remove the bolts ①.

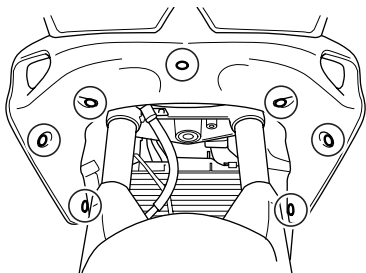

2. Remove the fasteners.

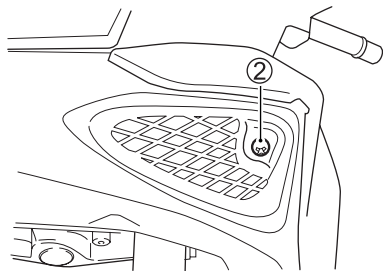

3. Remove the screws ②.

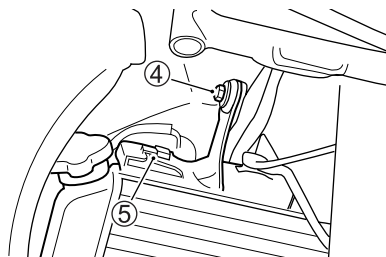
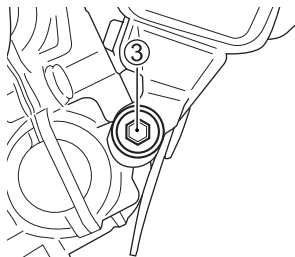

4. Remove the radiator mounting bolt ③ and ④.
5. Release the hook ⑤ and slide the radiator forward.

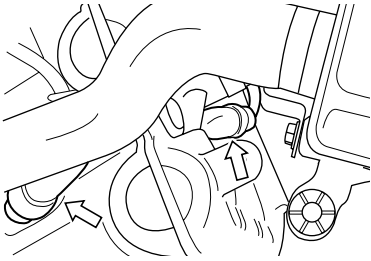

6. Pull off the spark plug cap.
7. Remove the spark plugs with a spark plug wrench.

NOTE: Be careful not to damage the radiator fins.

⚠ WARNING

A hot radiator and hot engine can burn you.

Wait until the radiator and engine are cool enough to touch with bare hands before starting this work.

Rear Side

1. Lift the fuel tank by referring to the FUEL TANK LIFT section.

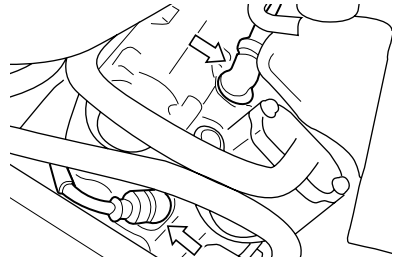

2. Remove the spark plugs with a spark plug wrench.

NOTE: Pry up the spark plug cap with a screwdriver or a bar if it is hard to remove by hand. Do not pull the spark plug cord.

CAUTION

Dirt can damage your engine if it enters an open spark plug hole.

Cover the spark plug hole whenever spark plug is removed.

Spark Plug Cleaning

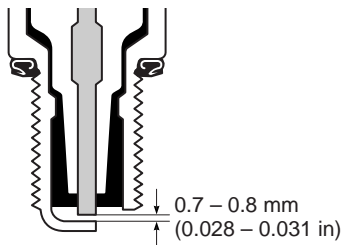

To maintain a hot, strong spark, keep the plugs free from carbon. Adjust the gap to 0.7 – 0.8 mm (0.028 – 0.031 in) for good ignition. Use a thickness (feeler) gauge to check the gap.

Installation

To install a spark plug, turn it in as far as possible with your fingers, then tighten it with a wrench.

CAUTION

A crossthreaded or overtightened spark plug will damage the aluminum threads of the cylinder head.

Follow the procedure below to tighten the spark plug properly.

Carefully turn the spark plug by hand into the threads until it is finger tight. If the spark plug is new, tighten it with a wrench about 1/2 turn past finger tight. If you are reusing the old spark plug, tighten it with a wrench about 1/8 turn past finger tight.

ENGINE OIL

Engine life depends on oil amount and quality. Daily oil level checks and periodic changes are two of the most important maintenance items to be performed.

Engine Oil Level Check

Check the engine oil level as follows:

1. Place the motorcycle on level ground on the side stand.
2. Start the engine and allow it to idle for a few minutes.
3. Stop the engine and wait for three minutes.

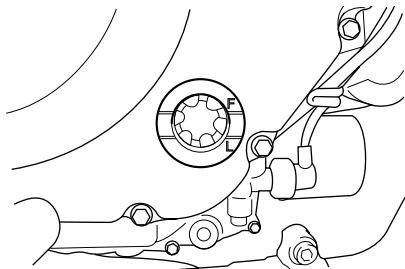

4. Hold the motorcycle vertically and check the oil level through the oil level inspection window on the right side of the engine. The engine oil level should be between "L" (low) and "F" (full) lines.

CAUTION

The engine oil level must be between the "L" (Low) line and "F" (Full) line, or engine damage may occur.

Inspect the oil level, through the inspection window, with the motorcycle held vertically on level ground before each use of the motorcycle.

Engine Oil and Filter Change

Change the engine oil and oil filter at the scheduled times. The engine should always be warm when the oil is changed so the oil will drain easily. The procedure is as follows:

1. Place the motorcycle on the side stand.

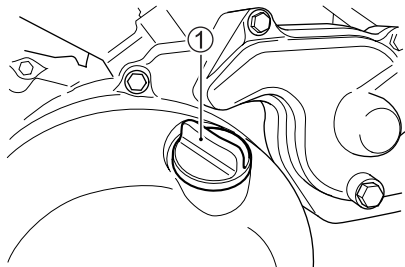

2. Remove the oil filler cap ①.

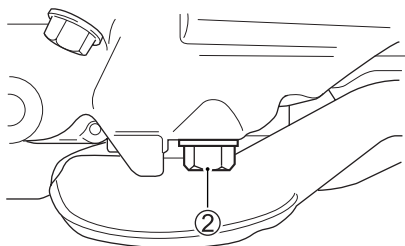

3. Remove the drain plug ② from the bottom of the engine and drain the engine oil into a drain pan.

⚠ WARNING

Engine oil and exhaust pipes can be hot enough to burn you.

Wait until the oil drain plug and exhaust pipes are cool enough to touch with bare hands before draining oil.

⚠ WARNING

New and used oil can be hazardous. Children and pets may be harmed by swallowing new or used oil. Repeated, prolonged contact with used engine oil may cause skin cancer. Brief contact with used oil may irritate skin.

- Keep new and used oil away from children and pets.
- Wear a long-sleeve shirt and waterproof gloves.
- Wash with soap if oil contacts your skin.

NOTE: Recycle or properly dispose of used oil.

4. Reinstall the drain plug and gasket. Tighten the plug securely with a wrench.

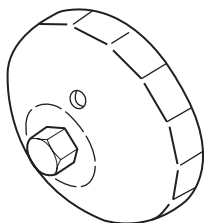

Oil filter wrench
(Part No. 09915-40620)

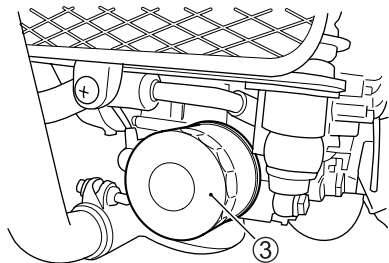

5. Turn the oil filter ③ counter-clockwise with a Suzuki “cap type” oil filter wrench or a “strap type” filter wrench of the proper size.

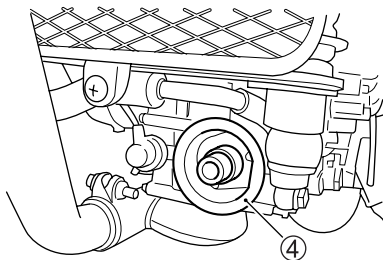

6. Wipe off the mounting surface ④ on the engine where the new filter will be seated with a clean rag.

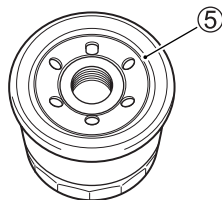

7. Smear a little engine oil around the rubber gasket ⑤ of the new oil filter.
8. Screw on the new filter by hand until the filter gasket contacts the mounting surface (small resistance will be felt).

CAUTION

Using an oil filter with the wrong design or thread specifications can cause oil leaks or engine damage.

Use a genuine SUZUKI oil filter or an equivalent filter designed for your motorcycle.

NOTE: To tighten the oil filter properly, it is important to accurately identify the position at which the filter gasket first contacts the mounting surface.

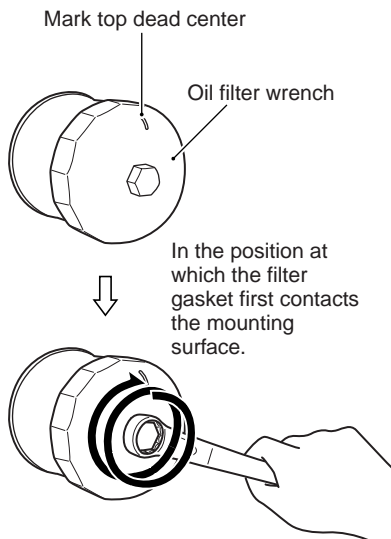

Tighten the filter 2 turns or to specified torque.

9. Mark the top dead center position on the "cap type" filter wrench or on the oil filter. Use an oil filter wrench to tighten the filter 2 turns or to specified torque.

Oil filter tightening torque:
20 N·m (2.0 kgf-m, 14.5 lbf-ft)

10. Reinstall the drain plug and tighten it securely. Pour about 2700 ml (2.9 US qt) of the specified engine oil in the filler hole. (See FUEL, ENGINE OIL AND COOLANT RECOMMENDATIONS section.)

NOTE: About 2300 ml (2.4 US qt) of oil will be required when changing oil only.

CAUTION

Engine damage may occur if you use oil that does not meet Suzuki's specifications.

Use the oil specified in the FUEL, ENGINE OIL AND COOLANT RECOMMENDATIONS section.

11. Reinstall the oil filler cap.
12. Start the engine (while the motorcycle is outside on level ground) and allow it to idle for a few minutes.
13. Turn the engine off and wait for three minutes. Recheck the oil level on the engine oil inspection window. The engine oil level should be at the "F" (full) mark. If it is lower than the "L" mark, add oil until it reaches the "F" mark. Inspect the area around the drain plug and oil filter for leaks.

ENGINE IDLE SPEED INSPECTION

Inspect the engine idle speed. The engine idle speed should be 1200 – 1400 r/min when the engine is warm.

NOTE: If the engine idle speed is not within the specified range, ask your Suzuki dealer or a qualified mechanic to inspect and repair the motorcycle.

THROTTLE CABLE PLAY

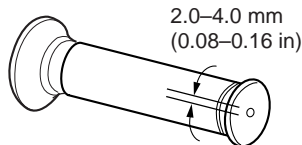
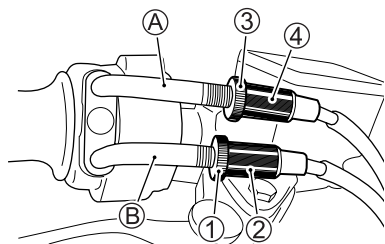

This motorcycle has a twin throttle cable system. Cable **A** is for pulling and cable **B** is for returning.

To adjust the cable play:

1. Loosen the lock nut **1**.
2. Turn in the adjuster **2** fully.
3. Loosen the lock nut **3**.
4. Turn the adjuster **4** so that the throttle grip has 2.0 – 4.0 mm (0.08 – 0.16 in) play.
5. Tighten the lock nut **3**.
6. While holding the throttle grip at the closed position, turn out the adjuster **2** to feel resistance.
7. Tighten the lock nut **1**.

⚠ WARNING

Inadequate throttle cable play can cause engine speed to rise suddenly when you turn the handlebar. This can lead to loss of rider control.

Adjust the throttle cable play so that engine idle speed does not rise due to handlebar movement.

FUEL HOSES

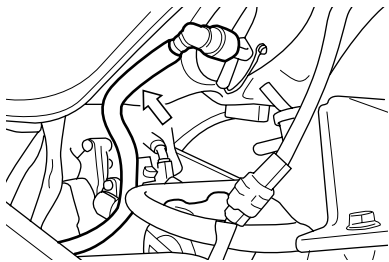

Inspect the fuel hose for damage and fuel leakage. If any defects are found, the fuel hose must be replaced.

ENGINE COOLANT

COOLANT LEVEL

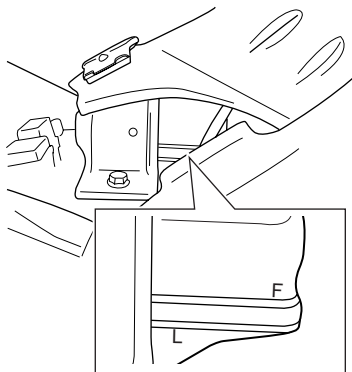

Remove the seat to check the coolant level. The engine coolant solution should be between the "F" (FULL) and the "L" (low) level lines on the engine coolant reservoir. If the level is lower than the "L" (low) level line, bring it up to the "F" (full) level by adding a 50:50 mixture of distilled water and engine coolant.

To add mixed coolant:

1. Lift the fuel tank by referring to the FUEL TANK LIFT section.

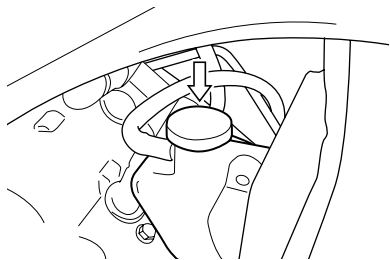

2. Remove the filler cap and add mixed coolant through the filler hole.

⚠ WARNING

Engine coolant is harmful or fatal if swallowed or inhaled.

Do not drink antifreeze or coolant solution. If swallowed, do not induce vomiting. Immediately contact a poison control center or a physician. Avoid inhaling mist or hot vapors; if inhaled, remove to fresh air. If coolant gets in eyes, flush eyes with water and seek medical attention. Wash thoroughly after handling. Solution can be poisonous to animals. Keep out of the reach of children and animals.

NOTE: Adding only water will dilute the engine coolant and reduce its effectiveness. Add a 50:50 mixture of engine coolant and water.

DRIVE CHAIN

This motorcycle has an endless drive chain constructed from special materials. It does not use a master link. The drive chain has special "O" rings that permanently keep grease inside. We recommend that you take your motorcycle to an authorized Suzuki dealer if the drive chain needs to be replaced.

The condition and adjustment of the drive chain should be checked before each use of the motorcycle. Always follow the guidelines below for inspecting and servicing the chain.

⚠ WARNING

Riding with the chain in poor condition or improperly adjusted can lead to an accident.

Inspect, adjust, and maintain the chain properly before each ride, according to this section.

Inspecting the Drive Chain

When inspecting the chain, look for the following:

- Loose pins
- Damaged rollers
- Dry or rusted links
- Kinked or binding links
- Excessive wear
- Improper chain adjustment

Damage to the drive chain means that the sprockets may also be damaged. Inspect the sprockets for the following:

Good

Worn

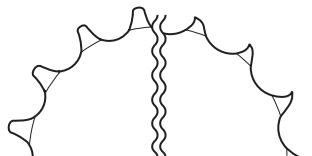

- Excessively worn teeth
- Broken or damaged teeth
- Loose sprocket mounting nuts

If you find any of these problems with your sprocket, consult your Suzuki dealer.

⚠ WARNING

Improperly installing a replacement chain, or using a joint-clip type chain, can be hazardous. An incompletely riveted master link, or a joint-clip type master link, may come apart and cause an accident or severe engine damage.

Do not use a joint-clip type chain. Chain replacement requires a special riveting tool and a high-quality, non-joint-clip type chain. Ask an authorized SUZUKI dealer or a qualified mechanic to perform this work.

Drive Chain Cleaning and Oiling

Clean and oil the chain as follows:

1. Wash the chain with kerosene. Kerosene will lubricate and clean the chain.

⚠ WARNING

Kerosene can be hazardous. Kerosene is flammable. Children or pets may be harmed from contact with kerosene.

Keep flames and smoking materials away from kerosene. Keep children and pets away from kerosene. If swallowed, do not induce vomiting. Call physician immediately. Dispose of used kerosene properly.

CAUTION

Cleaning the chain with gasoline or commercial cleaning solvents can damage O-rings and ruin the chain.

Clean the drive chain with kerosene only.

2. Allow the chain to dry, then lubricate the links with Suzuki chain lube or an equivalent chain lubricant.

CAUTION

Some drive chain lubricants contain solvents and additives which could damage the “O” rings in your chain.

Use Suzuki chain lube or an equivalent chain lubricant that is specifically intended for use with “O” ring chains.

Drive Chain Adjustment

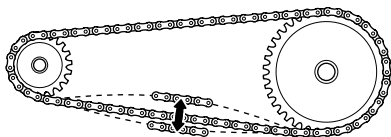

20 – 30 mm
(0.8 – 1.2 in)

Inspect the drive chain slack before each use of the motorcycle. Place the motorcycle on the side stand. The drive chain should be adjusted for 20 – 30 mm (0.8 – 1.2 in) of slack, as shown.

⚠ WARNING

Too much chain slack can cause the chain to come off the sprockets, resulting in an accident or serious damage to the motorcycle.

Inspect and adjust the drive chain slack before each use.

To adjust the drive chain, follow the procedure below:

⚠ WARNING

A hot muffler can burn you. The muffler will be hot enough to burn you for some time after stopping the engine.

Wait until the muffler cools to avoid burns.

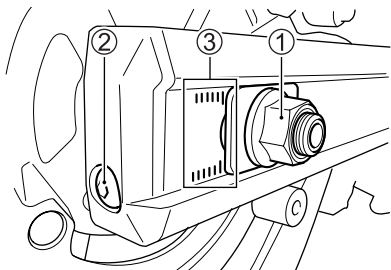

1. Place the motorcycle on the side stand.
2. Loosen the axle nut ①.
3. Turn the right and left adjuster bolts ② until the chain has 20 – 30 mm (0.8 – 1.2 in) of slack halfway between the engine sprocket and rear sprocket.

4. At the same time that the chain is being adjusted, the rear sprocket must be kept in perfect alignment with the front sprocket. To assist you in performing this procedure, there are reference marks ③ on the swingarm and each chain adjuster which are to be aligned with each other and to be used as a reference from one side to the other.
5. Tighten the axle nut ① securely.
6. Recheck the chain slack after tightening and readjust if necessary.

Rear axle nut tightening torque:
100 N·m (10.0 kgf·m, 72.5 lbf·ft)

CLUTCH

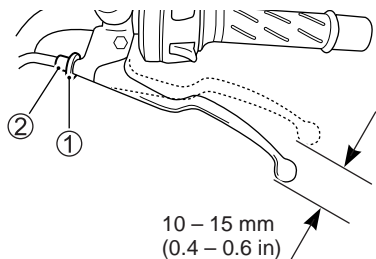

At each maintenance interval, adjust the clutch cable play with the clutch cable adjuster. The cable play should be 10 – 15 mm (0.4 – 0.6 in) as measured at the clutch lever end before the clutch begins to disengage. If you find the play of clutch incorrect, adjust it in the following way:

1. Loosen the lock nut ①.
2. Turn the clutch lever adjuster ② clockwise as far as it will go.

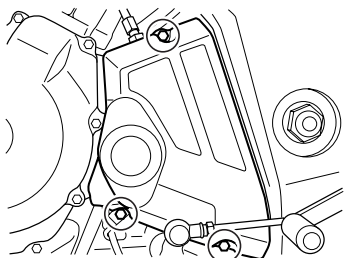

3. Remove the bolts and sprocket cover.

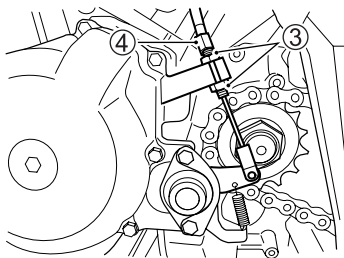

4. Loosen the cable adjuster lock nuts ③, and turn cable adjuster ④ to obtain approximately 10 – 15 mm (0.4 – 0.6 in) of free play at the clutch lever end as indicated.
5. Minor adjustment can now be made with the adjuster ②.
6. Tighten the lock nuts, ① and ③, after finishing adjustment.

NOTE: Any maintenance of the clutch other than the clutch cable play should be performed by your Suzuki dealer.

BRAKES

This motorcycle has front and rear disk brakes.

⚠ WARNING

Failure to inspect and properly maintain the brakes increases your chance of having an accident.

Inspect the brake system before each use according to the **INSPECTION BEFORE RIDING** section. Follow the **MAINTENANCE SCHEDULE** section to maintain your brake system.

NOTE: Operating in mud, water, sand or other extreme conditions can cause accelerated brake wear. If you operate your motorcycle under these conditions, the brakes must be inspected more often than recommended in the MAINTENANCE SCHEDULE.

Brake Fluid

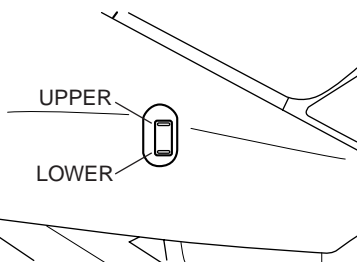
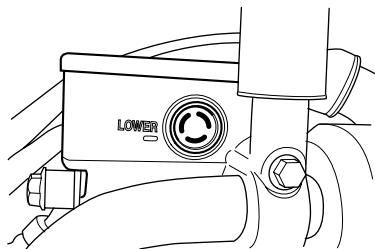

Check the brake fluid level in both the front and rear brake fluid reservoirs. Inspect for brake pad wear and leaks.

WARNING

Brake fluid is harmful or fatal if swallowed, and harmful if it comes in contact with skin or eyes.

If swallowed, do not induce vomiting. Immediately contact a poison control center or a physician. If brake fluid gets in eyes, flush eyes with water and seek medical attention. Wash thoroughly after handling. Solution can be poisonous to animals. Keep out of the reach of children and animals.

WARNING

Failure to keep the brake fluid reservoir full with proper brake fluid can be hazardous. The brakes may not work correctly without the proper amount and type of brake fluid. This could lead to an accident.

Inspect the brake fluid level before each use. Use only DOT4 brake fluid from a sealed container. Never use or mix with different types of brake fluid. If there is frequent loss of fluid, take your motorcycle to a SUZUKI dealer or a qualified mechanic for inspection.

CAUTION

Spilled brake fluid can damage painted surfaces and plastic parts.

Avoid spilling any fluid when filling the reservoir. Wipe up spills immediately.

Brake Pads

FRONT

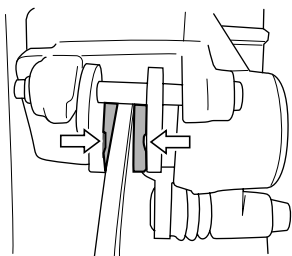

REAR

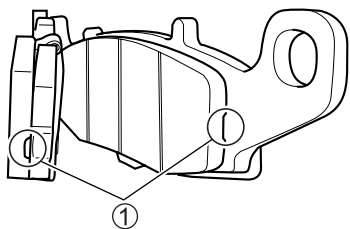
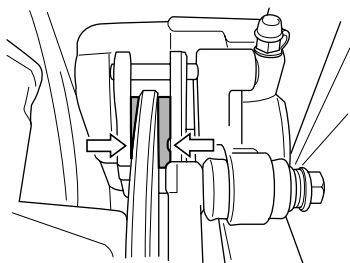

Inspect the front and rear brake pads to see if they are worn down to the grooved wear limit line ①.

If a front or rear pad is worn to the grooved limit line both front or both rear pads must be replaced with new ones by your authorized Suzuki dealer or qualified service

mechanic. After replacing either the front or rear brake pads, the brake lever or pedal must be pumped several times. This will extend the pads to their proper position.

▲ WARNING

Riding with worn brake pads will reduce braking performance and will increase your chance of having an accident.

Inspect brake pad wear before each use. Ask your SUZUKI dealer or a qualified mechanic to replace brake pads if any pad is worn to the limit.

▲ WARNING

Failure to extend brake pads after repair or replacement can cause poor braking performance and may result in an accident.

Before riding, “pump” the brake lever/pedal repeatedly until brake pads are pressed against the brake disks and proper lever/pedal stroke and firm feel are restored.

NOTE: Do not squeeze/depress the brake lever/pedal when the pads are not in their positions. It is difficult to push the pistons back into position.

⚠ WARNING

Replacing only one or the two brake pads can result in uneven braking action.

Replace both pads together.

Rear Brake Adjustment

The rear brake pedal must be adjusted to set the clearance between the pedal and the foot-rest. Adjust the brake pedal as follows:

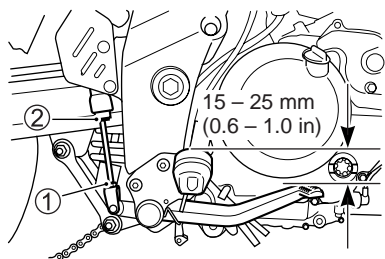

1. Loosen the lock nut ①, and turn the push rod ② to locate the pedal 15 – 25 mm (0.6 – 1.0 in) below the top face of the foot rest.
2. Retighten the lock nut ① to lock the push rod ② in the proper position.

CAUTION

An incorrectly adjusted brake pedal may force brake pads to rub against the disk at all times, causing damage to the pads and disk.

Follow the steps in this section to adjust the brake pedal properly.

Rear Brake Light Switch

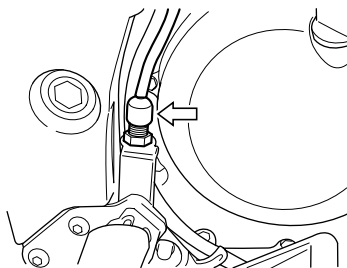

To adjust the brake light switch, hold the switch body and turn the adjuster so that the brake light will come on just before a pressure rise is felt when the brake pedal is depressed.

WARNING

Failure to follow these warnings may result in an accident due to tire failure. The tires on your motorcycle form the crucial link between your motorcycle and the road.

Follow these instructions:

- Check tire condition and pressure, and adjust pressure before each ride.
- Avoid overloading your motorcycle.
- Replace a tire when worn to the specified limit, or if you find damage such as cuts or cracks.
- Always use the size and type of tires specified in this owner's manual.
- Balance the wheel after tire installation.
- Read this section of the owner's manual carefully.

WARNING

Failure to perform break-in of the tires could cause tire slip and loss of control.

Use extra care when riding on new tires. Perform proper break-in of the tires referring to the **BREAK-IN** section and avoid hard acceleration, hard cornering, and hard braking for the first 160 km (100 miles).

Tire Pressure and Loading

Proper tire pressure and proper tire loading are important factors. Overloading your tires can lead to tire failure and loss of motorcycle control.

Check tire pressure each day before you ride, and adjust tire pressure according to the table below. Tire pressure should only be checked and adjusted before riding, since riding will heat up the tires and lead to higher inflation pressure readings.

Under-inflated tires make smooth cornering difficult, and can result in rapid tire wear. Over-inflated tires cause a smaller amount of tire to be in contact with the road, which can contribute to skidding and loss of control.

NOTE: When you detect drops in tire pressure, check the tire for nails or other punctures, or a damaged wheel rim. Tubeless tires sometimes lose pressure gradually when punctured.

LOAD TIRE	SOLO RIDING	DUAL RIDING
FRONT	225 kPa 2.25 kgf/cm ² 33 psi	225 kPa 2.25 kgf/cm ² 33 psi
REAR	250 kPa 2.50 kgf/cm ² 36 psi	280 kPa 2.80 kgf/cm ² 41 psi

Tire Condition and Type

Tire condition and tire type affect motorcycle performance. Cuts or cracks in the tires can lead to tire failure and loss of motorcycle control. Worn tires are susceptible to puncture failures and subsequent loss of motorcycle control. Tire wear also affects the tire profile, changing motorcycle handling characteristics.

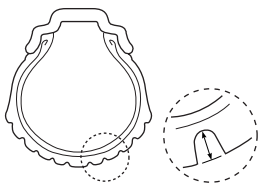

Check the condition of your tires each day before you ride. Replace tires if tires show visual evidence of damage, such as cracks or cuts, or if tread depth is less than 1.6 mm (0.06 in) front, 2.0 mm (0.08 in) rear.

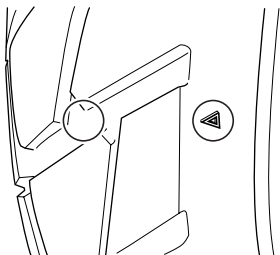

NOTE: The “△” mark indicates the place where the wear bars are molded into the tire. When the wear bars contact the road, it indicates that the tire wear limit has been reached.

Whenever you replace a tire, use a tire of the size and type listed below. If you use a different size or type of tire, motorcycle handling may be adversely affected, possibly resulting in loss of motorcycle control.

	FRONT	REAR
SIZE	110/80 R19 M/C 59H	150/70 R17 M/C 69H
TYPE	BRIDGESTONE TW101J	BRIDGESTONE TW152F

Always balance the wheel after repairing a puncture or replacing the tire. Proper wheel balance is important to avoid variable wheel-to-road contact, and to avoid uneven tire wear.

▲ WARNING

An improperly repaired, installed, or balanced tire can cause loss of control or shorten tire life.

- Ask your SUZUKI dealer or a qualified mechanic to perform tire repair, replacement, and balancing because proper tools and experience are required.
- Install tires according to the rotation direction shown by arrows on the sidewall of each tire.

⚠ WARNING

Failure to follow these instructions about tubeless tires may result in an accident due to tire failure. Tubeless tires require different service procedures than tube tires.

- Tubeless tires require an airtight seal between the tire bead and wheel rim. Special tire irons and rim protectors or a specialized tire mounting machine must be used for removing and installing tires to prevent tire or rim damage which could result in an air leak.
- Repair punctures in tubeless tires by removing the tire and applying an internal patch.
- Do not use an external repair plug to repair a puncture since the plug may work loose as a result of the cornering forces experienced by a motorcycle tire.
- After repairing a tire, do not exceed 80 km/h (50 mph) for the first 24 hours, 130 km/h (80 mph) thereafter. This is to avoid excessive heat build-up which could result in a tire repair failure and tire deflation.
- Replace the tire if it is punctured in the sidewall area, or if a puncture in the tread area is larger than 6 mm (3/16 in). These punctures cannot be repaired adequately.

SIDE STAND/IGNITION INTERLOCK SYSTEM

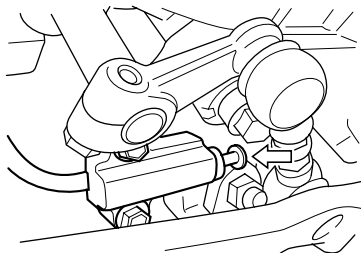

Check the side stand/ignition interlock system for proper operation as follows:

1. Sit on the motorcycle in the normal riding position, with the side stand up.
2. Shift into first gear, hold the clutch in, and start the engine.
3. While continuing to hold the clutch in, move the side stand to the down position.

If the engine stops running when the side stand is moved to the down position, then the side stand/ignition interlock system is working properly. If the engine continues to run with the side stand down and the transmission in gear, then the side stand/ignition interlock system is not working properly. Have your motorcycle inspected by an authorized Suzuki dealer or some other qualified service mechanic.

⚠ WARNING

If the side stand/ignition interlock system is not working properly, it is possible to ride the motorcycle with the side stand in the down position. This may interfere with rider control during a left turn.

Check the side stand/ignition interlock system for proper operation before riding. Check that the side stand is returned to its full up position before starting off.

FRONT WHEEL REMOVAL

1. Place the motorcycle on the side stand.

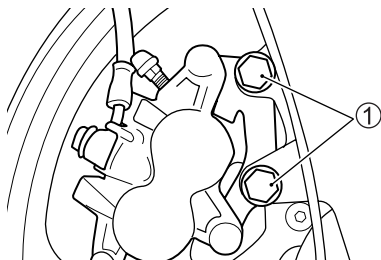

2. Remove both brake calipers from the front forks by removing two mounting bolts ① on each of the caliper.

NOTE: Never squeeze the front brake lever with the caliper removed. It is very difficult to force the pads back into the caliper assembly and brake fluid leakage may result.

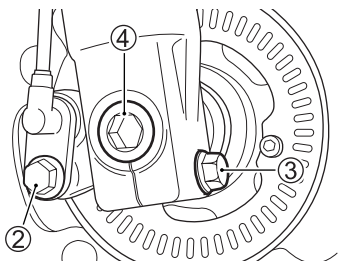

3. Remove the front wheel speed sensor by removing the mounting bolt ②.
4. Loosen the axle holder bolt ③ on the right front fork.
5. Loosen the axle ④ temporarily.

NOTE: A special tool is necessary to loosen the shaft ④. The special tool is available at Suzuki dealer.

6. Place an accessory service stand or equivalent under the swingarm to help stabilize the rear end.
7. Carefully position a jack under the engine and raise the jack until the front wheel is slightly off the ground.

CAUTION

Improper jacking may cause damage to the fairing or oil filter.

Do not apply the jack head to the fairing lower part or the oil filter when jacking up the motorcycle.

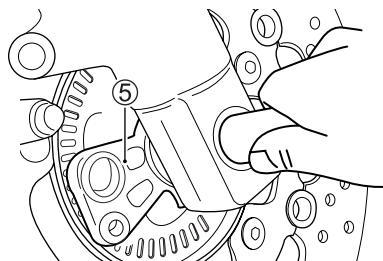

8. Turn the axle counterclockwise and draw it out.
9. Remove the front wheel speed sensor bracket ⑤.

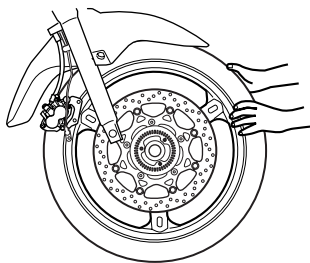

10. Slide the front wheel forward.
11. To reinstall the wheel assembly, reverse the sequence described above.
12. After installing the wheel, apply the front brake several times to restore the proper lever stroke.

WARNING

Failure to extend brake pads after installing the wheel can cause poor braking performance and may result in an accident.

Before riding, “pump” the brake repeatedly until the brake pads are pressed against the brake disks and proper lever stroke and firm feel are restored. Also check that the wheel rotates freely.

WARNING

Installing the front wheel in the reverse direction can be hazardous. The tire for this motorcycle is directional. Therefore, the motorcycle may have unusual handling if the wheel is installed incorrectly.

Install the front wheel in the specified direction, as indicated by the arrow on the sidewall of the tire.

WARNING

Failure to torque bolts and nuts properly could lead to an accident.

Torque bolts and nuts to the proper specifications. If you are not sure of the proper procedure, have your authorized SUZUKI dealer or a qualified mechanic do this.

Front axle tightening torque:
65 N·m (6.5 kgf-m, 47.0 lbf-ft)

Front axle holder bolt tightening torque:
23 N·m (2.3 kgf-m, 16.5 lbf-ft)

Front brake caliper mounting bolt tightening torque:
39 N·m (3.9 kgf-m, 28.0 lbf-ft)

NOTE: Be careful not to damage the oil seal when installing the front wheel.

REAR WHEEL REMOVAL

⚠ WARNING

A hot muffler can burn you. The muffler will be hot enough to burn you for some time after stopping the engine.

Wait until the muffler cools to avoid burns.

1. Place the motorcycle on the side stand.

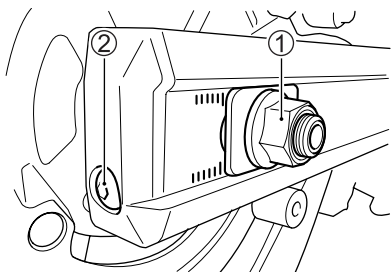

2. Remove the axle nut ①.
3. Place an accessory service stand or equivalent under the swingarm to lift the rear wheel slightly off the ground.
4. Loosen the right and left chain adjusting bolts ②.

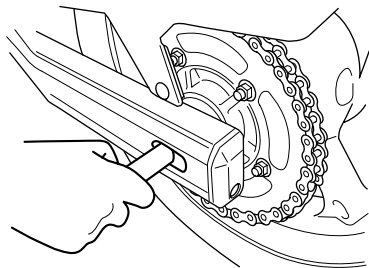

5. Remove the rear wheel speed sensor by removing the mounting bolt.
6. Draw out the axle shaft.

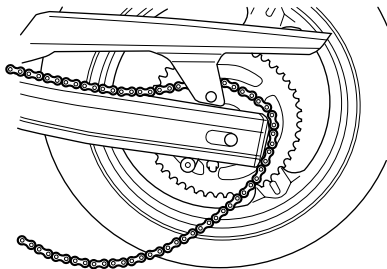

7. With the wheel moved forward, remove the chain from the sprocket.

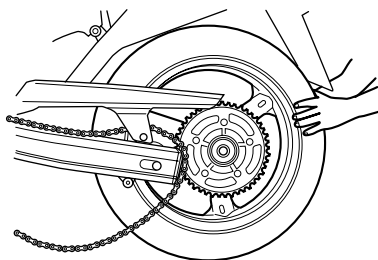

8. Pull the rear wheel assembly rearward.

NOTE: Never depress the rear brake pedal with the rear wheel removed. It is very difficult to force the pads back into the caliper assembly.

9. To replace the wheel, reverse the complete sequence listed.
10. After installing the wheel, apply the brake several times and then check that the wheel rotates freely.

WARNING

Failure to adjust the drive chain and failure to torque bolts and nuts properly could lead to an accident.

- **Adjust the drive chain as described in DRIVE CHAIN ADJUSTMENT section after installing the rear wheel.**
- **Torque bolts and nuts to the proper specifications. If you are not sure of the proper procedure, have your authorized SUZUKI dealer or a qualified mechanic do this.**

Rear axle nut tightening torque:
100 N·m (10.0 kgf·m, 72.5 lbf·ft)

WARNING

Failure to extend brake pads after installing the wheel can cause poor braking performance and may result in an accident.

Before riding, “pump” the brake repeatedly until brake pads are pressed against the brake disks and proper pedal stroke and firm feel are restored. Also check that the wheel rotates freely.

LIGHT BULB REPLACEMENT

The wattage rating of each bulb is shown in the following chart. When replacing a burned out bulb, always use the same wattage rating.

CAUTION

Using a light bulb with the wrong wattage rating can cause electrical system damage or shorten bulb life.

Always use the specified light bulb.

Headlight	12V 60/55W x 2 (H4)
Turn signal light	12V 21W
Brake light/Taillight	12V 21/5W x 2
License plate light	12V 5W

Headlight

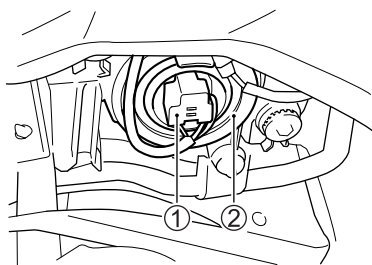

1. Disconnect the socket ① from the headlight and remove the rubber cap ②.

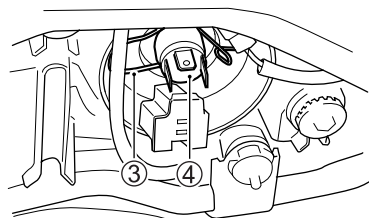

2. Unhook the bulb holder spring ③ and pull out the bulb ④.

CAUTION

Oil from your skin may damage the headlight bulb or shorten its life.

Grasp the new bulb with a clean cloth.

Headlight Beam Adjustment

The headlight beam can be adjusted both horizontally and vertically if necessary.

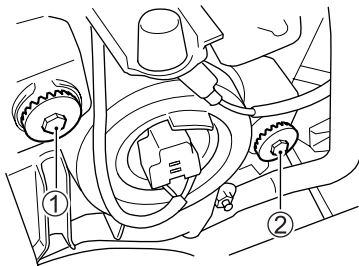

To adjust the beam horizontally:
Turn the adjuster ① clockwise or counterclockwise.

To adjust the beam vertically:
Turn the adjuster ② clockwise or counterclockwise.

NOTE: To adjust the headlight beam, adjust the beam horizontally first, then adjust vertically.

Turn Signal Light

To replace the turn signal light bulb, follow these directions.

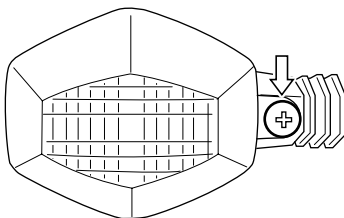

1. Remove the screw and take off the lens.

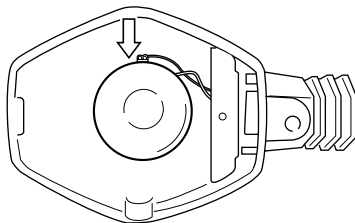

2. Push in on the bulb, turn it to the left, and pull it out.

CAUTION

Overtightening the screws when reinstalling the lens may cause the lens to crack.

Tighten the screws only until they are snug.

Brake Light/Taillight

To change the brake light/taillight bulb, perform the following steps:

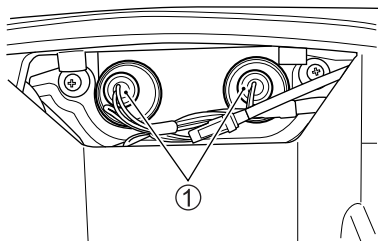

1. Turn the socket ① counter-clockwise and remove it.



2. Push in the bulb, turn it to the left and pull it off.

FUSES

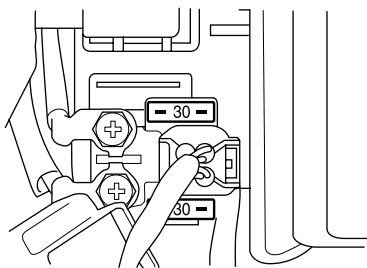

The main fuse is located under the seat. One 30A spare fuse is located in the fuse box.

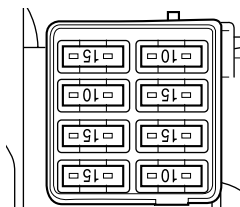

The fuses are located under the seat. Two spare fuses (one 10A and one 15A) are provided in the fuse box.

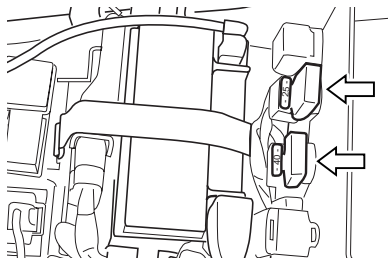

The ABS fuse is located under the seat. Two spare fuses (one 40A and one 25A) are provided in the fuse box.

The fuses are designed to open when an overload exists in individual electrical system circuits. If any electrical system fails to operate, then the fuses must be checked.

CAUTION

Installing a fuse of incorrect rating or using aluminum foil or wire instead of a fuse may seriously damage the electrical system.

Always replace a blown fuse with a fuse of the same type and rating. If the new fuse blows in a short time, consult your Suzuki dealer or a qualified mechanic immediately.

FUSE LIST

- 30A MAIN fuse protects the horn, indicator lights, turn signal lights, brake lights and license light.
- 15A HEAD-HI fuse protects the headlight high beam and high beam indicator light.
- 15A HEAD-LO fuse protects the headlight low beam.
- 10A FUEL fuse protects the ISC, ECU, instrument panel lights, fuel pump and injectors.
- 10A IGNITION fuse protects the ECU, PAIR solenoid, fuel pump relay, starter relay and ignition coils.
- 15A SIGNAL fuse protects the turn signal lights, brake/tail-light, license light, instrument panel lights and indicator lights.
- 15A FAN fuse protects the cooling fan motor.
- 40A ABS MOT fuse protects ABS system.
- 25A ABS VALVE fuse protects ABS system.



TROUBLESHOOTING

FUEL SYSTEM CHECK	8-2
IGNITION SYSTEM CHECK	8-3

TROUBLESHOOTING

This troubleshooting guide is provided to help you find the cause of some common complaints.

CAUTION

Failure to troubleshoot a problem correctly can damage your motorcycle. Improper repairs or adjustments may damage the motorcycle instead of fixing it. Such damage may not be covered under warranty.

If you are not sure about the proper action, consult your Suzuki dealer about the problem.

COMPLAINT: Engine is hard to start or does not start at all.

FUEL SYSTEM CHECK

If the meter indicates "FI", showing signs of trouble in the fuel injection system, take your machine to an authorized Suzuki dealer. Refer to the "INSTRUMENT PANEL" section for an explanation of the fuel injection system indicator. If the meter does not indicate "FI", make sure there is enough fuel in the fuel tank. If the meter does not indicate "FI" and there is enough fuel, the ignition system should be checked.

IGNITION SYSTEM CHECK

1. Remove the spark plugs and reattach them to the spark plug leads.
2. Put the engine stop switch in the "O" position and the ignition switch in the "ON" position. While holding a spark plug with its base firmly against the engine, push the electric starter button. If the ignition system is operating properly, a blue spark should jump across the spark plug gap.
3. If there is no spark, clean the spark plug. Replace it if necessary. Retry the above procedure with the cleaned spark plug or new one.
4. If there is still no spark, take your motorcycle to an authorized Suzuki dealer.

WARNING

Performing the spark test improperly can cause a high voltage electrical shock or an explosion.

Avoid performing this check if you are not familiar with this procedure, or if you have a heart condition or wear a pacemaker. Keep the spark plug away from the spark plug hole during this test.

COMPLAINT: Engine Stalls

1. Make sure there is enough fuel in the fuel tank.
2. If the coolant temperature meter indicates "FI", showing signs of trouble in the fuel injection system, take your machine to an authorized Suzuki dealer. Refer to the "INSTRUMENT PANEL" section for an explanation of the fuel injection system indicator.
3. Check the ignition system for intermittent spark.
4. Check the idle speed. The correct idle speed is 1200 – 1400 r/min.



STORAGE PROCEDURE AND MOTORCYCLE CLEANING

STORAGE PROCEDURE	9-2
PROCEDURE FOR RETURNING TO SERVICE	9-3
CORROSION PREVENTION	9-3
MOTORCYCLE CLEANING	9-4
INSPECTION AFTER CLEANING	9-6

STORAGE PROCEDURE AND MOTORCYCLE CLEANING

STORAGE PROCEDURE

If your motorcycle is to be left unused for an extended period of time, it needs special servicing requiring appropriate materials, equipment and skill. For this reason, Suzuki recommends that you trust this maintenance work to your Suzuki dealer. If you wish to service the machine for storage yourself, follow the general guidelines below:

MOTORCYCLE

Clean the entire motorcycle. Place the motorcycle on the side stand on a firm, flat surface where it will not fall over. Turn the handlebars all the way to the left and lock the steering, and remove the ignition key.

FUEL

1. Fill the fuel tank to the top with fuel mixed with the amount of gasoline stabilizer recommended by the stabilizer manufacturer.
2. Run the engine for a few minutes until the stabilized gasoline fills the fuel injection system.

ENGINE

1. Pour one tablespoon of motor oil into each spark plug hole. Reinstall the spark plugs and crank the engine a few times.
2. Drain the engine oil thoroughly and refill the crankcase with fresh engine oil all the way up to the filler hole.
3. Cover the air cleaner intake and the muffler outlet with oily rags to prevent humidity from entering.

BATTERY

1. Remove the battery from the motorcycle.
2. Clean the outside of the battery with mild soap and remove corrosion from the terminals and wiring harness.
3. Store the battery in a room above freezing.

TIRES

Inflate tires to the normal pressure.

EXTERNAL

- Spray all vinyl and rubber parts with rubber protectant.
- Spray unpainted surfaces with rust preventative.
- Coat painted surfaces with car wax.

MAINTENANCE DURING STORAGE

Once a month, recharge the battery. The standard charging rate is 1.2A x 5 – 10 hours.

PROCEDURE FOR RETURNING TO SERVICE

1. Clean the entire motorcycle.
2. Remove the oily rags from the air cleaner intake and muffler outlet.
3. Drain all the engine oil. Install a new oil filter and fill the engine with fresh oil as outlined in this manual.
4. Remove the spark plugs. Turn the engine a few times. Reinstall the spark plugs.
5. Reinstall the battery.
6. Make sure that the motorcycle is properly lubricated.
7. Perform the **INSPECTION BEFORE RIDING** as listed in this manual.
8. Start the motorcycle as outlined in this manual.

CORROSION PREVENTION

It is important to take good care of your motorcycle to protect it from corrosion and keep it looking new for years to come.

Important Information About Corrosion

Common causes of corrosion

- Accumulation of road salt, dirt, moisture, or chemicals in hard-to-reach areas.
- Chipping, scratches, and any damage to treated or painted metal surfaces resulting from minor accidents or impacts from stones and gravel.

Road salt, sea air, industrial pollution, and high humidity will all contribute to corrosion.

How to Help Prevent Corrosion

- Wash your motorcycle frequently, at least once a month. Keep your motorcycle as clean and dry as possible.
- Remove foreign material deposits. Foreign material such as road salt, chemicals, road oil or tar, tree sap, bird droppings and industrial fall-out may damage your motorcycle's finish. Remove these types of deposits as soon as possible. If these deposits are difficult to wash off, an additional cleaner may be required. Follow the manufacturer's directions when using these special cleaners.

- Repair finish damage as soon as possible. Carefully examine your motorcycle for damage to the painted surfaces. Should you find any chips or scratches in the paint, touch them up immediately to prevent corrosion from starting. If the chips or scratches have gone through to the bare metal, have a Suzuki dealer make the repair.
- Store your motorcycle in a dry, well-ventilated area. If you often wash your motorcycle in the garage or if you frequently park it inside when wet, your garage may be damp. The high humidity may cause or accelerate corrosion. A wet motorcycle may corrode even in a heated garage if the ventilation is poor.
- Cover your motorcycle. Exposure to mid-day sun can cause the colors in paint, plastic parts, and instrument faces to fade. Covering your motorcycle with a high-quality, “breathable” motorcycle cover can help protect the finish from the harmful UV rays in sunlight, and can reduce the amount of dust and air pollution reaching the surface. Your Suzuki dealer can help you select the right cover for your motorcycle.

MOTORCYCLE CLEANING

Washing the Motorcycle

When washing the motorcycle, follow the instructions below:

1. Remove dirt and mud from the motorcycle with running water. You may use a soft sponge or brush. Do not use hard materials which can scratch the paint.
2. Wash the entire motorcycle with mild detergent or car wash soap using a sponge or soft cloth. The sponge or cloth should be frequently soaked in the soap solution.

CAUTION

Radiator fins can be damaged by spraying high pressure water on them.

Do not spray high pressure water on the radiator fins.

NOTE: Avoid spraying or allowing water to flow over the following places:

- *Ignition switch*
- *Spark plugs*
- *Fuel tank cap*
- *Fuel injection system*
- *Brake master cylinders*

CAUTION

High pressure washers and parts cleaner can damage your motorcycle.

Do not use high pressure washers to clean your motorcycle. Do not use parts cleaner to throttle body and fuel injection sensors.

3. Once the dirt has been completely removed, rinse off the detergent with running water.
4. After rinsing, wipe off the motorcycle with a wet chamois or cloth and allow it to dry in the shade.
5. Check carefully for damage to painted surfaces. If there is any damage, obtain "touch-up" paint and "touch-up" the damage.

CAUTION

Cleaning with any alkaline or strong acid cleaner gasoline, brake fluid, or any other solvent will damage the motorcycle parts.

Clean only with soft cloth and warm water with mild detergent.

Windshield Cleaning

Clean the windshield with a soft cloth and warm water with a mild detergent. If scratched, polish with a commercially available plastic polish. Replace the windshield if it becomes scratched or discolored so as to obstruct view. When replacing the windshield, use a Suzuki replacement windshield.

Waxing the Motorcycle

After washing the motorcycle, waxing is recommended to further protect and beautify the paint. Observe the precautions specified by the wax manufacturer.

Special Care for Matte Finish Paint

- Do not use polishing compounds or waxes that contain polishing compounds on surfaces which have a matte finish. The use of polishing compounds will change the appearance of the matte finish.
- Solid type waxes may be difficult to remove from surfaces with a matte finish.
- Excessive rubbing or polishing of a surface with a matte finish will change its appearance.

INSPECTION AFTER CLEANING

For extended life of your motorcycle, lubricate according to “GENERAL LUBRICATION” section.

WARNING

Wet brakes can cause poor braking performance and may lead to an accident.

Avoid a possible accident by expecting longer stopping distances after washing your motorcycle. Apply brakes several times to let heat dry the brake pads or shoes.

Follow the procedures in the “INSPECTION BEFORE RIDING” section to check your motorcycle for any problems that may have arisen during your last ride.

CONSUMER INFORMATION

EMISSION CONTROL WARRANTY	10-2
REPORTING SAFETY DEFECTS	10-2
TAMPERING WITH NOISE CONTROL SYSTEM PROHIBITED	10-3
ON-BOARD MOTORCYCLE COMPUTER DATA INFORMATION	10-4
SERIAL NUMBER LOCATION	10-5
LOCATION OF LABELS	10-6

CONSUMER INFORMATION

EMISSION CONTROL WARRANTY

Suzuki Motor Corporation warrants to the ultimate purchaser and each subsequent purchaser that this vehicle is designed, built, and equipped so as to conform at the time of sale with all U.S. emission standards applicable at the time of manufacture, and that it is free from defects in materials and workmanship which would cause it not to meet these standards within its useful life. Useful life is defined for each class of motorcycle as 5 years or the corresponding number of kilometers (miles) shown in the chart below, whichever occurs first.

Vehicle class	Engine displacement	Useful Life Distance
Class I	50 to 169 cc	12000 km (7456 miles)
Class II	170 to 279 cc	18000 km (11185 miles)
Class III	280 cc and over	30000 km (18641 miles)

Failures, other than those resulting from defects in material or workmanship, which arise solely as a result of owner abuse and/or lack of proper maintenance are not covered by the warranty.

REPORTING SAFETY DEFECTS

If you believe that your vehicle has a defect which could cause a crash or could cause injury or death, you should immediately inform the National Highway Traffic Safety Administration (NHTSA) in addition to notifying American Suzuki Motor Corp.

If NHTSA receives similar complaints, it may open an investigation, and if it finds that a safety defect exists in a group of vehicles, it may order a recall and remedy campaign. However, NHTSA cannot become involved in individual problems between you, your dealer, or American Suzuki Motor Corp.

To contact NHTSA, you may either call the Vehicle Safety Hot Line toll-free 1-888-327-4236 (TTY: 1-800-424-9153); go to <http://www.safercar.gov>; or write to: Administrator, NHTSA, 400 Seventh Street, SW., Washington DC 20590. You can also obtain other information about motor vehicle safety from <http://www.NHTSA.gov>.

To contact American Suzuki, owners in the continental United States can call toll-free 1-800-444-5077, or write to: American Suzuki Motor Corporation Motorcycle Customer Service P.O. Box 1100, Brea, CA 92822-1100.

For owners outside the continental United States, please refer to the distributor's address listed on your Warranty Information brochure.

TAMPERING WITH NOISE CONTROL SYSTEM PROHIBITED

Federal law prohibits the following acts or the causing thereof;

1. The removal or rendering inoperative by any person other than for purposes of maintenance, repair, or replacement, of any device or element of design incorporated into any new vehicle for the purpose of noise control prior to its sale or delivery to the ultimate purchaser or while it is in use, or
2. The use of the vehicle after such device or element of design has been removed or rendered inoperative by any person.

Among those acts presumed to constitute tampering are the acts listed below:

- Removing or puncturing the muffler, baffles, header pipes, screen type spark arrester (if equipped) or any other component which conducts exhaust gases.
- Replacing the exhaust system or muffler with a system or muffler not marked with the same model specific code as the code listed on the Motorcycle Noise Emission Control Information label, and certified to appropriate EPA noise standards.
- Removing or puncturing the air cleaner case, air cleaner cover, baffles, or any other component which conducts intake air.

Whenever replacing parts on your motorcycle, Suzuki recommends that you use genuine Suzuki replacement parts or their equivalent.

ON-BOARD MOTORCYCLE COMPUTER DATA INFORMATION

Your motorcycle is equipped with on-board computer systems which monitor and control several aspects of motorcycle performance, including the following:

- Emission-related components and engine parameters such as engine speed and throttle position are monitored to provide emission control and to provide optimum fuel economy. Your motorcycle also has an on-board diagnostic system which monitors and records information about emission-related malfunctions.
- If your motorcycle is equipped with antilock brakes, conditions such as motorcycle speed and brake performance are monitored, so that the ABS system can provide effective antilock braking.

Some information may be stored by the on-board computer when malfunctions occur. This stored information can assist technicians in repairing the motorcycle. To read the stored information, special equipment is needed and access to the motorcycle or storage device is required. In addition, once SUZUKI collects or receives data, SUZUKI may use the data for research conducted by SUZUKI, make the data available for outside research if need is shown and confidentiality is assured, or make summary data which does not identify specific motorcycles available for outside research.

Others, such as law enforcement personnel, may have access to the special equipment that can read the information if they have access to the motorcycle or storage device.

SERIAL NUMBER LOCATION

You need to know the frame and engine serial numbers to get title documents for your motorcycle. You also need these numbers to help your dealer when you order parts.

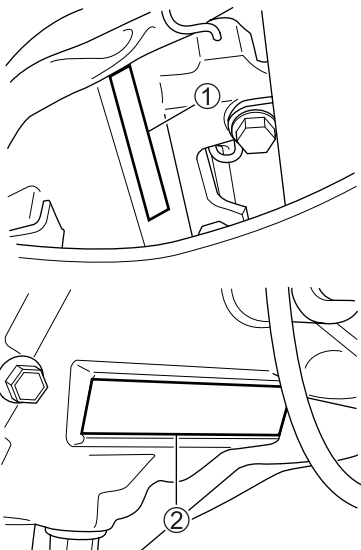

The frame number ① is stamped on the steering head as shown in the illustration. The engine serial number ② is stamped on the right side of the crankcase assembly.

Write down the serial numbers here for your future reference.

Frame No.:

Engine No.:

LOCATION OF LABELS

Read and follow all of the warnings labeled on your motorcycle. Make sure you understand all of the labels. Keep the labels on your motorcycle. Do not remove them for any reason.

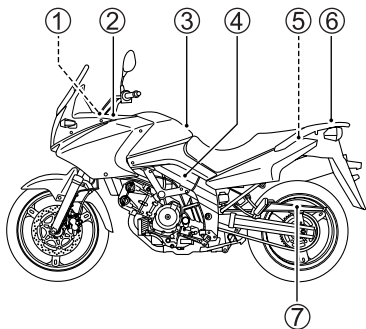

①

▲ WARNING

Do not carry any objects in the space behind the fairing or on the fairing support bars. Objects placed in these area can interfere with steering and can cause loss of control.

②

▲ WARNING

- Keep windshield clean at all times.
- Clean only with a soft cloth and warm water with a mild detergent.
- Minor scratches may be removed by polishing with a commercially available plastic polish. Make sure the plastic polish does not contain an abrasive compound, as it may cause permanent scratches.
- Replace windshield if it becomes scratched or discolored so as to interfere with view.
- Avoid using any alkaline or strong acid cleaner, gasoline, brake fluid, or any other solvent.
- When replacing windshield, use Suzuki replacement windshield.

③

▲ WARNING

Failure to follow these safety precautions may increase your risk of injury:

- Wear a helmet, eye protection, and bright protective clothing.
- Don't ride after consuming alcohol or other drugs.
- Slow down on slippery surfaces, unfamiliar terrain, or when visibility is reduced.
- Read owner's manual carefully.

④

⚠ WARNING

Never make any modifications to the aluminum alloy frame, such as drilling or welding. Such modifications will weaken the frame and may lead to an accident.

⑤

The owner's manual contains important safety information and instructions which should be read carefully before operating the vehicle. If the vehicle has been resold, obtain the owner's manual from the previous owner or contact your local SUZUKI dealer for assistance.

⑥

⚠ WARNING

MAXIMUM LOAD : 10 kg (22 lbs)

⑦

⚠ WARNING

- Check tire condition, wear, and cold tire pressure before each ride.
- Replace only with TUBELESS tires of listed size and type.
- Read Owner's manual for more information.

COLD TIRE PRESSURE	SOLO RIDING			DUAL RIDING		
	kPa	kgf/cm ²	psi	kPa	kgf/cm ²	psi
FRONT	225	2.25	33	225	2.25	33
REAR	250	2.50	36	280	2.80	41
		FRONT		REAR		
	TIRE SIZE	110/80R19M/C 59H		150/70R17M/C 69H		
	TYPE	BRIDGESTONE	TW101 J	TW152 F		

SPECIFICATIONS

DIMENSIONS AND CURB MASS

Overall length	2290 mm (90.2 in)
Overall width.....	840 mm (33.1 in)
Overall height	1390 mm (54.7 in) ... Low windshield position (STD)
	1420 mm (55.9 in) ... Middle windshield position
	1450 mm (57.1 in) ... High windshield position
Wheelbase	1555 mm (61.2 in)
Ground clearance.....	165 mm (6.5 in)
Seat height	820 mm (32.3 in)
Curb mass.....	220 kg (485 lbs)

ENGINE

Type.....	4-stroke, Liquid-cooled, DOHC, 90° degree V-twin
Number of cylinders	2
Bore.....	81.0 mm (3.189 in)
Stroke	62.6 mm (2.465 in)
Displacement.....	645 cm ³ (39.4 cu. in)
Compression ratio	11.5 : 1
Fuel system	Fuel injection system
Air cleaner	Non-woven fabric element
Starter system.....	Electric
Lubrication system	Wet sump

DRIVE TRAIN

Clutch	Wet multi-plate type
Transmission	6-speed constant mesh
Gearshift pattern	1-down, 5-up
Primary reduction ratio	2.088 (71/34)
Gear ratios, Low	2.461 (32/13)
2nd	1.777 (32/18)
3rd	1.380 (29/21)
4th	1.125 (27/24)
5th	0.961 (25/26)
Top.....	0.851 (23/27)
Final reduction ratio.....	3.133 (47/15)
Drive chain	DID525V8, 118 links

CHASSIS

Front suspension	Telescopic, coil spring, oil damped
Rear suspension	Link type, coil spring, oil damped
Front fork stroke	150 mm (5.9 in)
Rear wheel travel.....	150 mm (5.9 in)
Caster.....	26°
Trail.....	110 mm (4.33 in)
Steering angle	40° (right and left)
Turning radius.....	2.6 m (8.5 ft)
Front brake	Disk brake, twin
Rear brake	Disk brake
Front tire size.....	110/80 R19 M/C 59H, tubeless
Rear tire size	150/70 R17 M/C 69H, tubeless

ELECTRICAL

Ignition type	Electronic ignition (Transistorized)
Spark plug	NGK CR8E or DENSO U24ESR-N
Battery	12V 36.0 kC(10 Ah)/10 HR
Generator	Three-phase A.C. generator
Main fuse	30A
Fuse	15/15/10/10/15/15A
ABS fuse	40/25A
Headlight	12V 60/55W x 2 (H4)
Brake light/Taillight.....	12V 21/5W x 2
License plate light.....	12V 5W
Turn signal light	12V 21W
Speedometer light	LED
Tachometer light	LED
Turn signal indicator light.....	LED
Neutral indicator light.....	LED
High beam indicator light.....	LED
Oil pressure/Coolant temperature	
/Fuel injection indicator light	LED
ABS indicator light	LED

CAPACITIES

Fuel tank, including reserve	22.0 L (5.8 US gal)
Engine oil, oil change	2300 ml (2.4 US qt)
With filter change	2700 ml (2.9 US qt)
Engine coolant.....	1.9 L (2.0 US qt)

INDEX

- A**
ACCESSORIES AND
LOADING 1-5
ACCESSORY INSTALLATION
GUIDELINE 6-2
ACCESSORY USE 6-2
AIR CLEANER 7-9
- B**
BATTERY 7-8
BE EXTRA SAFETY-
CONSCIOUS ON BAD
WEATHER DAYS 1-4
BE STREET SMART 1-6
BRAKES 7-29
- C**
CARRYING A
PASSENGER 1-5,5-8
CLUTCH 7-28
CONCLUSION 1-6
CORROSION
PREVENTION 9-3
- D**
DRIVE CHAIN 7-24
- E**
EMISSION CONTROL
WARRANTY 10-2
ENGINE COOLANT 7-22
ENGINE COOLANT
SOLUTION 2-5
ENGINE IDLE SPEED
INSPECTION 7-20
ENGINE OIL 2-3,7-16
- F**
FRONT WHEEL
REMOVAL 7-37
FUEL 2-2
FUEL HOSES 7-22
FUEL SYSTEM CHECK 8-2
FUEL TANK CAP 3-18
FUEL TANK LIFT 7-5
FUSES 7-44
- G**
GEARSHIFT LEVER 3-19
- H**
HELMET HOLDER 3-20

I	
IF A COLLISION IS IMMINENT, DO SOMETHING!	1-3
IF YOU DON'T HAVE A HELMET - BUY A HELMET, AND WEAR IT EVERY TIME YOU RIDE	1-2
IGNITION SWITCH	3-5
IGNITION SYSTEM CHECK.....	8-3
INSPECTION AFTER CLEANING	9-6
INSPECTION BEFORE RIDING.....	1-5,4-3
INSTRUMENT PANEL.....	3-7
K	
KEY	3-5
KNOW YOUR LIMITS	1-4
L	
LEFT HANDLEBAR.....	3-14
LOADING GUIDELINES	6-4
LOADING LIMIT	6-3
LOCATION OF LABEL.....	10-6
LOCATION OF PARTS.....	3-2
LUBRICATION POINTS.....	7-7
M	
MAINTENANCE SCHEDULE	7-2
MODIFICATION	6-4
MOST ACCIDENTS CAN BE AVOIDED	1-2
MOTORCYCLE CLEANING	9-4
MOTORCYCLE SAFETY FOUNDATION'S "RIDING TIPS AND PRACTICE GUIDE" HANDBOOK (FOR OWNERS IN USA)	1-6
N	
NOTICE	7-2
O	
ON-BOARD MOTORCYCLE COMPUTER DATA INFORMATION	10-4
P	
PRACTICE AWAY FROM TRAFFIC	1-4
PROCEDURE FOR RETURNING TO SERVICE.....	9-3

R		T	
REAR BRAKE PEDAL	3-19	TAMPERING WITH NOISE CONTROL SYSTEM	
REAR WHEEL		PROHIBITED.....	10-3
REMOVAL.....	7-40	THROTTLE CABLE	
REPORTING SAFETY DEFECTS.....	10-2	PLAY	7-21
RIDING ON HILLS	5-5	TIRES	7-33
RIGHT HANDLEBAR	3-15	TOOLS	7-5
S		U	
SEAT LOCK	3-20	USING THE TRANSMISSION	5-4
SERIAL NUMBER LOCATION.....	10-5	W	
SIDE STAND.....	3-21	WINDSHIELD HEIGHT ADJUSTMENT	3-24
SIDE STAND/IGNITION INTERLOCK SYSTEM.....	7-36		
SPARK PLUG	7-12		
SPECIAL SITUATIONS REQUIRE SPECIAL CARE	1-3		
STARTING OFF AND SHIFTING.....	5-3		
STARTING THE ENGINE.....	5-2		
STOPPING AND PARKING	5-5		
STORAGE PROCEDURE	9-2		
SUSPENSION ADJUSTMENT	3-22		

WARNING

Failure to follow these safety precautions may increase your risk of injury:

- Wear a helmet, eye protection, and bright protective clothing.
- Don't ride after consuming alcohol or other drugs.
- Slow down on slippery surfaces, unfamiliar terrain, or when visibility is reduced.
- Read owner's manual carefully.



K9

SUZUKI MOTOR CORPORATION

300 TAKATSUKA, MINAMI, HAMAMATSU, JAPAN

Printed in Japan